

INSTRUCTION MANUAL

MULTI-STAGE DRY VACUUM PUMP

MODEL ESA500W

STANDARD MODEL

200V (50Hz), 200-220V (60Hz)

440V (50Hz), 400-480V (60Hz)



Caution:

Please read and understand this INSTRUCTION MANUAL thoroughly before using this equipment.

Be sure to keep this INSTRUCTION MANUAL on hand for future reference

To Facility and Tool Manufactures:

Be sure to distribute this INSTRUCTION MANUAL to all end-user personnel actually operation this equipment.

「Model OOO」 in this INSTRUCTION MANUAL is our model code

ISSUED BY PRECISION MACHINERY COMPANY

Do not reproduce or reprint any portion of this manual without permission.
Manufacturer reserves the right to discontinue or change any specifications
or designs without notice and without incurring obligations.
Model OOO in this catalog is our model code.

All rights reserved, copyright EBARA Corporation.

Environmental Basic Policies

It is our responsibility, as people of the earth, to protect nature's irreplaceable treasures and to pass them on to future generations.

As we undertake our business activities, we will establish environmental management systems and implement ongoing improvements and reviews, while striving to promote harmony between technology and nature, prevent environmental pollution, and improve the overall results of our environmental management activities. We are aware that environmental protection and management activities are the responsibility of all managers and employees of the Corporation, and each person will demonstrate this awareness when carrying out his or her duties.

We will widely publicize these basic policies to regional societies and the general public and work to make Ebara's position on the environment clear to society in general.

Safety Information

It is essential that those operating this pump should have the knowledge to identify and avoid hazardous conditions associated with the pump.

Inadequate or rash operation may cause dangerous and serious accidents.

Before installation and operation, the operator should first have a good knowledge of the pump construction, operation procedure, and its hazards.

The operator should read through this instruction manual and other documents issued by EBARA in detail.

If you have any questions on pump operation, safeties, and maintenance, please do not hesitate to contact EBARA directly. Refer to Global network for contact address.

Three terms designating the level of hazard are used in this manual.



DANGER

Indicates an imminently hazardous situation which, if not avoided, will result in death or serious injury.



WARNING

Indicates a potentially hazardous situation which, if not avoided, could result in death or serious injury.











CAUTION

Indicates an imminently hazardous situation which, if not avoided, may result in minor or moderate injury.

This term may also be used as a warning for situations liable to damage to equipment.

Important Prior Warnings

-  **DANGER** Keep out from under the pump when lifted.
Only qualified personnel shall unload and lift the pump.
Keep pump at horizontal position when lifted.
Do not lift the pump without eyebolt spacer.
-  **WARNING** Be careful not to overturn the pump when pushing and pulling it sideways, because the width of the pump is small to its height.
-  **WARNING** All electrical works must be performed by only a qualified electrician.
All national and local electrical regulations must be observed.
-  **WARNING** Interrupt Earth Leakage Breaker (ELB) before starting on wiring and maintenance work.
Do not switch on the power supply to the pump until work is completed.
-  **WARNING** Supply N₂ gas to the exhaust piping when necessary to dilute the inflammable or toxic gas up to a safe concentration.
-  **WARNING** Purge with sufficient N₂ gas before removing and washing the vacuum and exhaust piping.
Do not let inflammable, toxic or dangerous materials disperse and guard against contact with the human body.
Always work in a location with an escape route in an emergency.
-  **WARNING** Do not use the pump for another process without a previous overhaul. Gases or reaction products remaining in the pump will react and lead to accidents with the formation of large amounts of products.
-  **WARNING** Pump oil may be contaminated with process byproducts. Treat it as a hazardous waste. See Table 3.1 for oil quantities.

 **WARNING** To avoid any hazard induced by toxicity, flammability and explosiveness of the process gases used in the tool, be sure to operate the tool according to the operations safety guidelines supplied by tool suppliers. Appendix 6 lists typical process gases used in a semiconductor-processing tool. However, details concerning the tool gases and other concerns specific to your tool should be directed to the respective tool suppliers.

 **WARNING** Check for gas leaks after installing and maintaining the piping. Gas leaks will result in the discharge of harmful and dangerous substances and in abnormal reactions due to the ingress of air into the pump. When checking for gas leaks by pressurization, please pressurize by less than 0.05 MPa into the purge port and do check.

 **WARNING** Do not alter the pump member nor change any parts without the EBARA's consent or approval.

 **WARNING** The pump casing and exhaust piping become extremely hot during operation and for some time after stopping. Be sure that pump and exhaust piping do not come in contact with humans or inflammable substances. Do not remove the pump cover during operation.

 **WARNING** Check Safety Interlock functions periodically (every 6 months) to confirm the interlocks will work correctly.

 **CAUTION** Disposal of process by-products shall be strictly in accordance with all local and national environmental and safety regulations.

 **CAUTION** Disposal of Printed circuit board containing Lithium battery shall be strictly in accordance with all local and national environmental and applicable regulations.

 **WARNING** In designing the dry pumps, Ebara does not assume risks caused by hazardous chemical reactions resulted from simultaneous injection or mixture of multiple process gases in the pumps, and the pump is not equipped with a protection against the dangers from such pump usage. The tool suppliers and users must pay attention not to simultaneously inject or mix those gases.

 **WARNING** Do not perform a withstand voltage test. Failure to comply could result in damage to the sensitive devices.

 **CAUTION** Never operate the pump without pump cover for safety.

(vi)

The following safety warning labels are attached to pump covers.

1. High temperature warning
2. Hazardous voltage warning
3. Hazardous materials warning
4. Electric charge mark
5. Hazardous weight danger

1. High temperature warning
Hot surface may burn or cause injury.
Allow the piping and casing to cool before servicing.



2. Hazardous voltage warning
Hazardous Voltage may shock, burn, or cause death.
Turn power off and lockout before servicing.

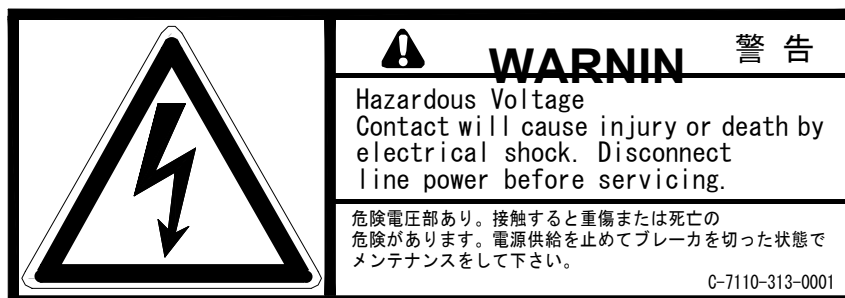

3. Hazardous materials warning

In case of hazardous materials are handled. Run the pump only with N₂ gas purge before servicing. Take adequate measures against dangerous reaction and contact with human body.



4. Electric charge mark

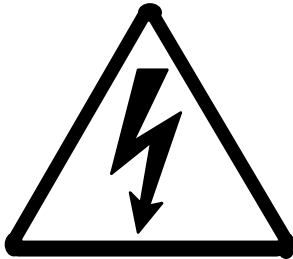

5. Hazardous weight danger

Heavy weight may cause severe injury or death due to overturning or falling pump. Keep out from under the lifted pump.

Raise all adjuster-feet fully when moving.

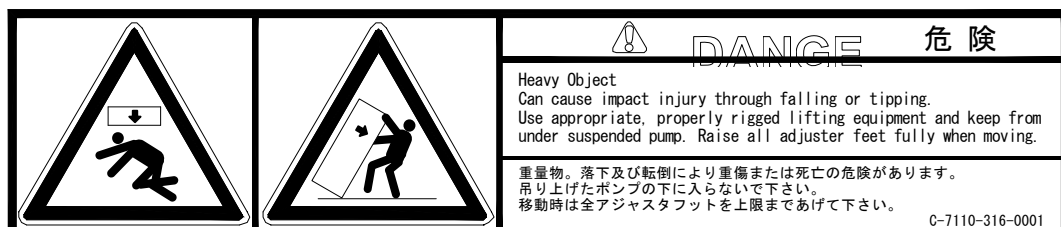

Standard Limited Warranty

The terms of this Warranty limit the liability of EBARA CORPORATION. Read it carefully.

Duration

For new pumps, the Warranty period shall be one (1) year from the date of commencing operation by user or 18 months from shipment by EBARA, whichever comes first. This Warranty does not apply to service beyond these time periods.

For overhauled pumps, the warranty period shall be six (6) months from shipment by EBARA.

Coverage

For the duration of the Warranty period, EBARA warrants this ESA pump from failure due to defects in materials or workmanship. For such failures, EBARA will, at its option, either replace or repair the pump free of charge

Such repair or replacement will not extend the duration of the warranty beyond the original period.

For repairs not covered under this Warranty, EBARA will charge the customer for parts and labor.

Exclusions and Limitations

This Warranty does not cover the following:

1. Failure due to operating the pump in a manner or under conditions other than as described in the instruction manual.
2. Failure due to corrosion, byproducts or foreign material entering the pump.
3. Failure due to fire, flood, earthquake, Acts or God, Acts of War or other circumstances beyond EBARA's control.

Disassembly or repair of the pump by parties other than EBARA or EBARA-authorized suppliers will void this Warranty.

EBARA's liability is limited to repair or replacement of the pump under Warranty. EBARA accepts no liability for consequential damages, including injury to personnel and damage to facilities, tools or product.

EBARA makes no Warranty of merchantability, beyond statutory requirements, or of fitness for a specific purpose.

Contents

Environmental Basic Policies.....	i
Safety Information.....	ii
Important Prior Warnings.....	iii
Standard Limited Warranty.....	ix
Contents.....	x
1. Foreword.....	1
2. Introduction.....	1
2.1 Introduction.....	1
2.2 Environmental Concerns.....	2
3. Product Description.....	3
3.1 Outline.....	3
3.1.1 Pump Module.....	3
3.1.2 N2 Gas.....	3
3.1.3 Cooling Water.....	4
3.1.4 Exhaust.....	4
3.2 Control System.....	4
3.2.1 Warning.....	4
3.2.2 Operation Status Control.....	5
3.3 The way of pump moving.....	5
3.3.1 Preparation.....	5
3.3.2 Moving method.....	6
3.4 Detailed Specifications.....	7
4. Installation.....	11
4.1 Movement and Fixation.....	11
4.1.1 Location.....	11
4.1.2 Caster and adjustment foot.....	11
4.2 Piping.....	13
4.2.1 Vacuum and Exhaust Piping.....	13
4.2.2 Cooling Water Piping.....	14
4.2.3 N2 Gas Piping.....	16
4.2.4 Ventilation Duct.....	16
4.3 Electrical Wiring.....	18
4.3.1 Grounding.....	19
4.3.2 Power Supply Wiring.....	20
4.3.3 Control Signal Wiring.....	21
5. Power Supply for accessories.....	24

6. LCD Controller	25
6.1 LCD Outline	25
6.2 LCD Indication	26
6.3 Setting the operational mode	30
6.3.1 Setting the pump operation control mode	32
6.3.2 Setting the DIP switch	32
6.3.3 Setting the pump running mode	33
6.3.4 Setting the BP normal rotational speed.....	33
6.3.5 Setting the rotational speed in the LOW SPEED mode	33
6.3.6 Setting the pump N2 flow	34
6.3.7 Setting the WARNING value for the back pressure (option).....	35
6.4 Dip Switch.....	36
6.5 Dip Switch setting display	40
6.6 Starting/stopping the pump with the LCD controller.....	41
7. Operation	42
7.1 Before Starting.....	42
7.2 START/STOP	44
7.2.1 LOCAL Start/Stop	45
7.2.2 REMOTE Start/Stop	46
7.2.3 COMMUNICATION Start/Stop.....	47
8. Maintenance and Inspection	48
8.1 Internal energies	48
8.1.1 Power source.....	48
8.1.2 Cooling water.....	48
8.1.3 N2 gas	48
8.2 Routine Inspection	49
8.3 Vacuum and Exhaust Piping.....	51
8.4 Lubricant Oil	52
8.5 Spare (Maintenance) Parts List	55
8.6 List of wastes during maintenance	56
8.7 Overhaul	57
9. Disconnection and Transportation	58
10. Troubleshooting	61
10.1 Troubleshooting (1) Basic trouble	61
10.2 Troubleshooting (2) WARNING	63
10.3 Troubleshooting (3) ALARM	65
10.4 Troubleshooting (4) Option	68

1. Foreword

We appreciate that you have selected an EBARA dry vacuum pump model ESA500W. This pump has been manufactured with much care and attention so that it can be operated safely and satisfactorily.

Incorrect operation will result in lack of performance and cause accidents and injuries to personnel.

[NOTE] This instruction manual contains all necessary information on operation and maintenance of the pump.

Be sure to operate the pump correctly in accordance with these instructions to ensure a long service life.

Keep this instruction manual in a suitable place for immediate reference whenever needed.

2. Introduction

2.1 Introduction

Check the following items on receipt of the pump package.

(1) Check that the nameplate affixed to the outer cover of the pump to confirm that the pump supplied agrees with your order.

Check the accessories against the packing list and the previously submitted drawings and documents to confirm that the all ordered accessories have been supplied.

(2) Check whether damage has occurred or screws/bolts have worked themselves loose in transit.



CAUTION Notify EBARA without delay when damage is discovered or when components are missing. Do not use when a leak is present as this will result in accident.

(3) Store the pump in a dry and clean place if it is not installed at once after delivery.

Temperature : 5-40°C
Humidity : 80% or less

(4) Do not stack the pump. Pump must be placed in an upright position.

2.2 Environmental Concerns

Handling or operating the unit other than specified may induce adverse impacts on the environment. Follow the descriptions below to handle, operate, and maintain the unit.

- (1) Ask an authorized waste-disposal company to dispose packing materials from uncrating according to laws and ordinances applicable to the waste.
- (2) Failure to do the unit maintenance (including overhaul) may trigger accidents causing injury or death, unit troubles, or environmental pollution. Plan the maintenance and perform it periodically to operate the unit efficiently.
- (3) To dispose the unit, follow effective laws and ordinances applicable in the area where the unit is installed.
- (4) To dispose the lubricant oil and chemicals, follow effective laws and ordinances applicable in the area where the unit is installed.

 WARNING	If the pump becomes damaged during shipment or if parts are missing, immediately contact EBARA. If a leaking or damaged product is used, an accident resulting in injury or death could occur or the product could become further damaged. Even if leakage occurs, take measures to ensure they will not be directly discharged from the site, as such leakage also wastes resources.
--	---

 CAUTION	If the product is not to be immediately installed, store it in a clean, dry location.
--	---

3. Product Description

3.1 Outline

This dry vacuum pump has a compact design and includes various sensors and controls to enhance reliability and operation.

3.1.1 Pump Module

The pump is a Roots type vacuum pump which rotates a pair of non-contact multi-stage rotors synchronized by timing gears. In the unit, a Booster Pump (BP) and the Main Pump (MP) are connected in series for ventilation.

The timing gears and bearings are enclosed in a compartment that is independent of the casing. For lubrication Perfluoro-Polyether (PFPE) oil and grease are used.

The pump is filled with lubrication oil. Use only the recommended lubrication oil grades shown in specification Table 3.1 for replenishing or replacing.

3.1.2 N2 Gas

Introduce N2 gas to dilute the hazardous gases to an unarmful level. Properly connect the N2 gas line to the purge port provided according to the instructions in Table 3.1 and the descriptions in Section 4.2.3. In the cases the gas concentration may become higher than the specified for safe gas exhaust, introduce the N2 gas to lines to the exhaust outlet. The tool user shall provide the purge port for this purpose.

N2 gas is also required to supply to seal the shaft section. This protects the penetration to bearing section, such as corrosive gas.

To reduce pump corrosion due to process gas or accumulation of reaction by-products, N2 gas is supplied to each pump component as dilution purge gas. Stopping the dilution N2 with a selector valve can save N2 gas, when process does not produce corrosion and reaction by-products.

The correct amount of N2 gas is supplied for those two types of purge operation, by adjusting the regulation pressure to the specified value.

The N2 gas selector is locating on the right side of the unit, facing the LCD controller and other utility connectors. It is under the outer cover.

3.1.3 Cooling Water

Because the pump compresses gas from a vacuum to atmospheric pressure, compression heat is generated. Therefore cool the motor with cooling water. The cooling water connector takes the form of a coupler for easy connection and disconnection.

3.1.4 Exhaust

A check valve is provided as a standard accessory to prevent reverse flow of gas from the exhaust through the pump to the vacuum chamber when pump is stopped.

3.2 Control System

This pump has a built-in measuring unit consisting of a Earth Leakage Breaker (ELB), an electro-magnetic switch and a control circuit.

To improve reliability and safety, the condition of each utility and pump section is monitored by a sensor.

During pump operation all operating conditions are monitored, including power supply, cooling water flow, N₂ gas flow, casing and motor coil temperature, motor speed, and motor current.

Continuous operation is possible when there is a momentarily power failure of 1 sec or less.

3.2.1 Warning

To assure the reliability of the pump as a vacuum exhaust system, the pump protection system generates two levels of alarm: WARNING and ALARM.

A WARNING signal is generated when pump operation exceeds the normal range. It therefore only draws attention that the normal operating values are not adhered to but does not signify that danger is imminent. The pump will continue to operate in this condition.

An ALARM signal output is generated and the pump will stop automatically

when the upper mechanical safety limit is reached during pump operation.

When an ALARM output is suddenly generated, while the plant unit is operational, a WARNING signal will be generated to ensure that the plant operation is not discontinued. This enables the operator to check the pump after the equivalent of one cycle has been completed.

Be sure to contact EBARA Corporation for details on checking the WARNING and ALARM setting conditions.

- Note that the warning indications of the Model ESA500W dry pump are different from the conventional pumps like as UERR, A, AA, AAS series, based on SEMI standard E73.

	UERR,A,AA, and AAS	Model ESA500W
Alarm 1 (Pump operation continued)	ALARM	WARNING
Alarm 2 (Pump stop)	TRIP	ALARM

3.2.2 Operation Status Control

The sensor data are displayed on the LCD display provided on the controller to facilitate operation status control and daily inspection.

All WARNING and ALARM signals are displayed on the LCD display. For remote operation and monitoring, the signals are available as individual and group outputs.

3.3 The way of pump moving

3.3.1 Preparation

Before pump moving, all adjuster feet shall be raised fully at four places.

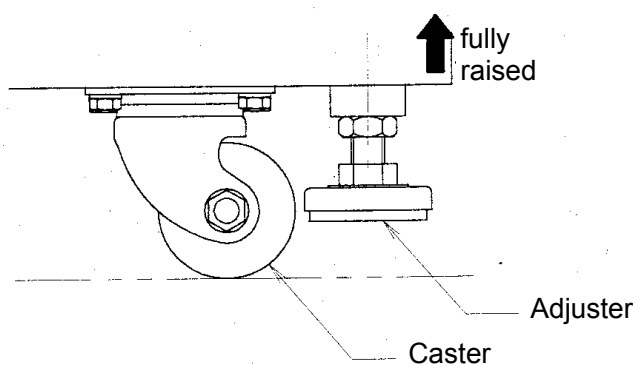

In case of being not raised fully, pump may be tripped over by obstacle on floor.

3.3.2 Moving method

Move pump slowly by pushing eye bolt toward direction A. Be sure not to be caught by toes. If pump needs to be moved toward direction B in order to be set at a corner or narrow spaces, two persons shall move the pump by pushing its terminal portion alternately as directed below.

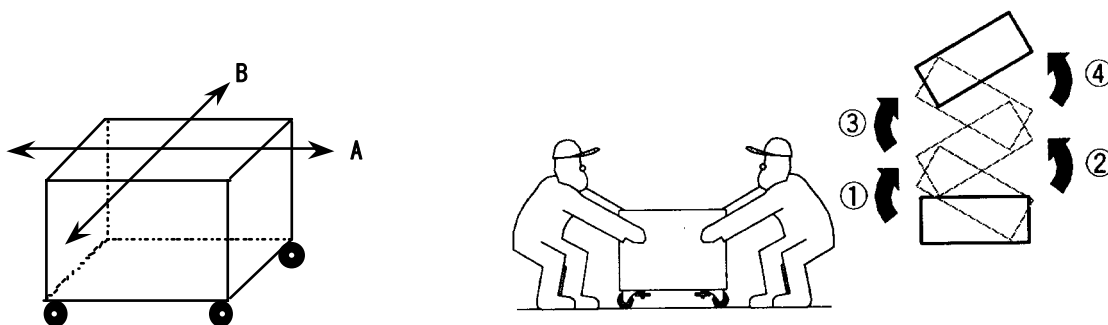

If pump needs to be moved on steps or ditches, spread steel plate or the like which can sustain the pump weight over the steps / ditches and pump shall be moved on it by two persons with care.

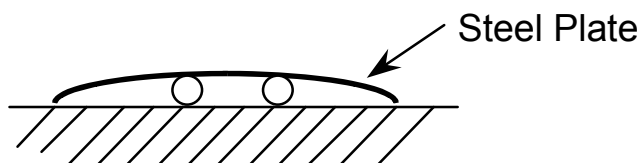

If pump should lose its balance when moving and start tripping over, never try to sustain the pump, get away from the pump immediately.

3.4 Detailed Specifications

The following tables and figures should be consulted for pump specification, dimension and performance details.

Table 3.1 Specification

Model		Model ESA500W		
Pumping Speed (50 / 60Hz)		47000 / 50000 L/min		
Ultimate Pressure		1.0 Pa		
Connection	Gas Inlet	ISO160		
	Gas Outlet	NW50		
Approx. Power at Ultimate Pressure (Motor Power)		5.1kW : 50Hz , 6.7kW ; 60Hz 33.2 kW		
Utility	Cooling Water	Connection	Coupler(Rc3/8)	
		Pressure [Gauge Press.]	Differential Press. : Min. 0.28MPa Supply: Max. 0.5MPa	
		Flow rate	6 - 9 L/min	
		Temperature	Max. 30 deg C	
	N2 Gas	Connection	1/4" Tube Fitting(Same as Swagelok)	
		Pressure [Gauge Press.]	Supply : 0.15 - 0.7MPa [Setting : 0.09 - 0.12MPa]	
		Approx. Flow rate	8.5 ~ 11.0 Pa m ³ /s	
	Duct Ventilation *	Connection	d 50 mm x L 50 mm	
		Pressure	-196 Pa	
		Approx. Flow rate	0.5 m ³ /min	
Lubrication Oil	Brand	BARRIERTA J100ES (NOK)		
	Quantity	1.5 L		
Approx. Weight		750 kg		
Power Supply	Phase/Volt/Freq.	[200V Model] 3 Phase , 200V (50Hz), 200-220V (60Hz)		
		[460V Model] 3 Phase , 440V (50Hz), 440-480V (60Hz)		
	Current Rating	[200V Model]	175A trip	
		[460V Model]	75A trip	
Power capacity	41.3 kVA (50 / 60Hz)			
Connection	[Breaker]	:M8 Crimp-style circle terminal		
	[Earth]	:M5 Crimp-style circle terminal		
Control Signal		D-sub 15 Pin + D-sub 25 Pin		

[Note] * The ambient temperature of the pump installation place shall be 30 degrees of centigrade of lower.

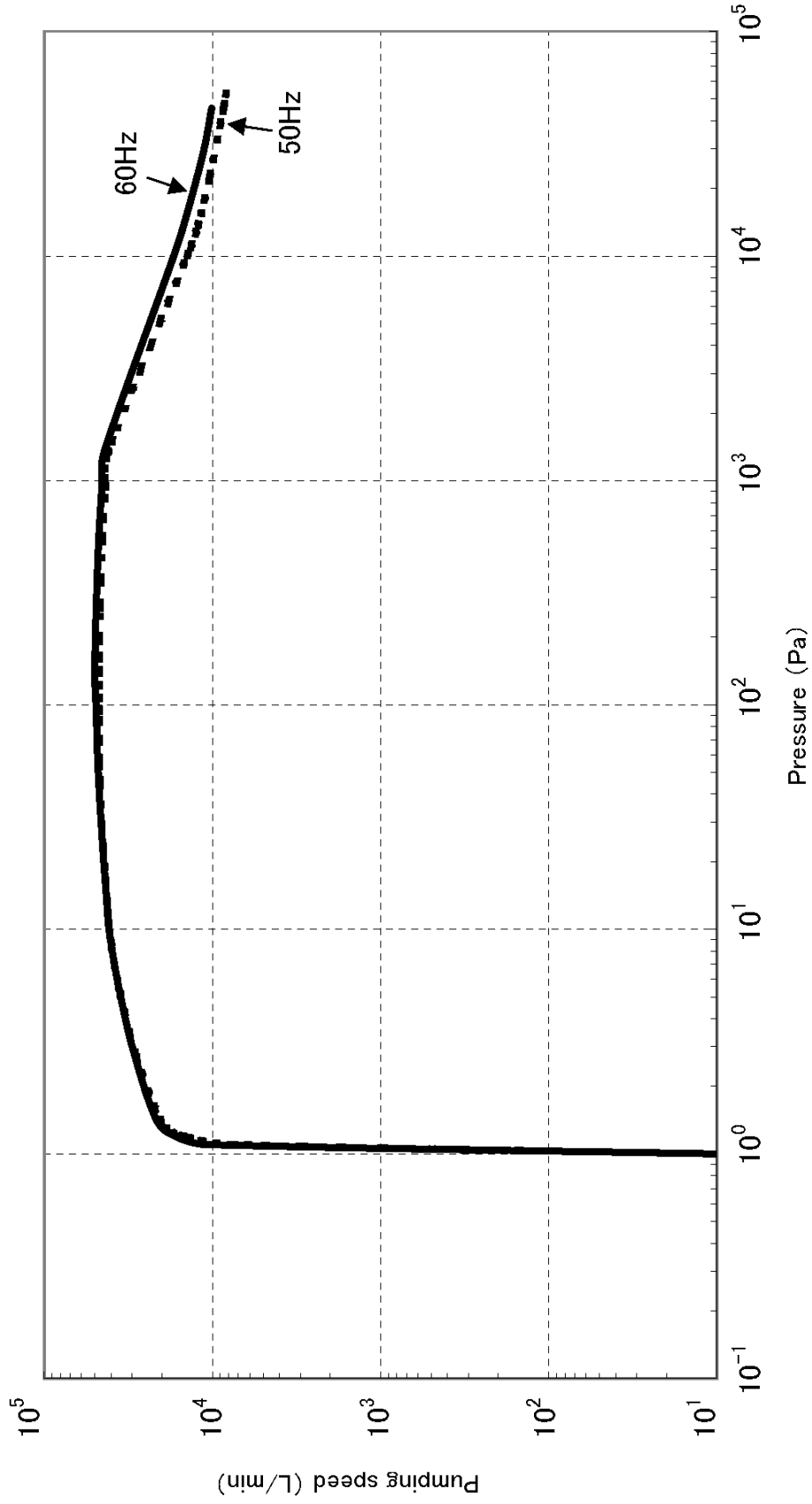

Fig. 3.1 Model ESA500W Performance curve

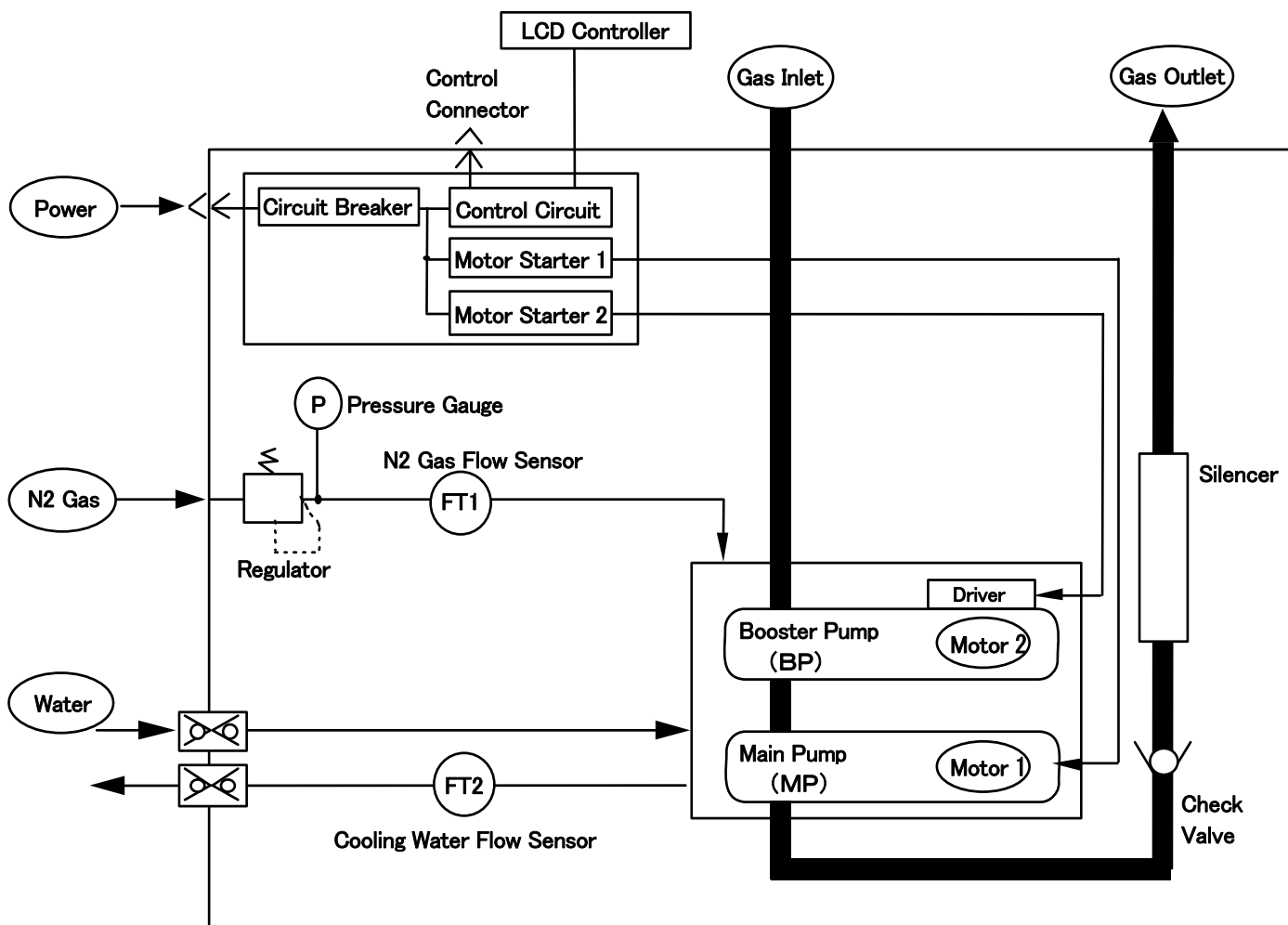

Fig. 3.2 System Flow

4. Installation

Be sure to take the following cautions and instructions into account when installing the pump.

4.1 Movement and Fixation

4.1.1 Location

This pump is designed for indoor installation. To install the pump, select a place with little exposure to dust and humidity and not subject to dew condensation. Also allow for sufficient space to ensure easy pump installation and disassembly for maintenance.

In case of installing interface box to the pump, the distance between pump and interface box shall be 3m or less.



CAUTION Install pump in a location at an ambient not exceeding 30°C. Particular caution is required when the pump is operated in an enclosed room.





CAUTION A gap of at least 50mm should be left open for ventilation between the pump cover and the adjacent equipment.

4.1.2 Caster and adjustment foot

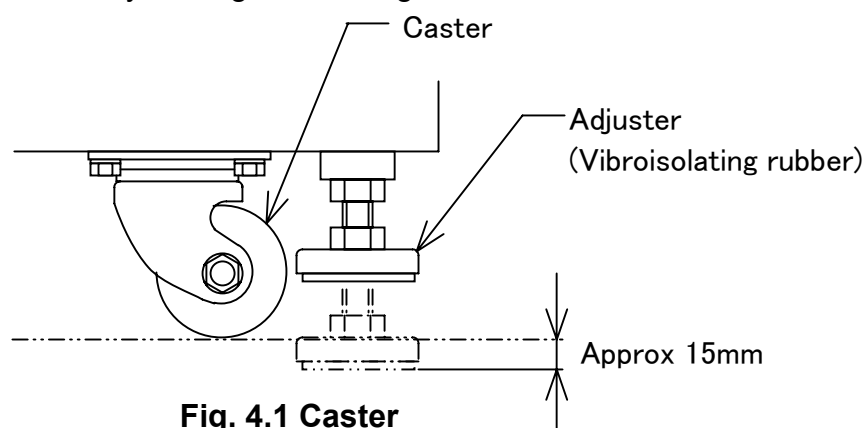
Four integral mobile support units consisting of a caster and a height-adjustment foot each are provided underneath the pump base. To move the pump, raise the four adjustment feet by turning the holding nuts in the counterclockwise direction.



 **WARNING** Be careful not to overturn the pump when pushing and pulling it sideways, because the width of the pump is small to its height.

 **CAUTION** The neck portion of the casters will vibrate during caster movement. Be sure to keep your fingers and feet out.

 **CAUTION** Do not step on the pump or place objects on it.

- (1) To fix the pump, turn the adjusters to the right to lower them.
- (2) Level the pump by adjusting adjusters. Check the levelness by a put level on the inlet flange. If you cannot check the level, you should keep a difference of height between the both sides of the pump base less than 1mm.
The adjustment allowance is approximately 15 mm.

[**NOTE**] If the pump is not leveled, shortage of the lubrication oil supply to the bearing may be caused.

[**NOTE**] To prevent vibrations and airborne noises, keep horizontal level of pump with the adjustment feet.

4.2 Piping

4.2.1 Vacuum and Exhaust Piping

Connect the vacuum and exhaust pipes to the inlet and exhaust flanges.

A narrow clearance is maintained in the pump for rotor rotation. The ingress of foreign objects into the pump interior will therefore prevent the pump from operating. Be sure that therefore to heed the following cautions when making the pipe connections.

- a) Remove all foreign matter from inside the piping.
- b) When connecting be sure that no dirt or dust particles adhere to the flange surfaces and/or that the flange surfaces are not damaged.
Provide a suitable means of preventing the ingress of reaction by-products adhering to the APC valve and wafer fragments. For this purpose, equip with a filter may be recommended.
- c) The weight of the pipes attached to the pump can cause misalignment and leaks from the flange connections. Be sure that therefore to support the piping properly and not to apply undue force when aligning the flange faces.
It is recommended to insert flexible bellows when connecting the pipes to the suction and exhaust flanges of the pump.
The length of the flexible bellows on the vacuum (suction) side will vary according to the vacuum drawn. Be sure to connect so that no undue force can be applied to the flexible bellows.



WARNING

Be sure to check for leaks after you have installed the pump. Leaks will cause serious danger due to the discharge of harmful and hazardous substances and the occurrence of unpredictable reactions associated with the admission of air into the pump. When checking for gas leaks by pressurization, please pressurize by less than 0.05 MPa into the purge port and do check.

4.2.2 Cooling Water Piping

Be sure to connect the cooling water pipes to the correct inlet and outlet ports. The connector ports are provided with couplers. Push in the plug till the end of socket. Socket sleeve returns to front. (Fig. 4.2)

Be sure that the supply/return plugs are not connected in reverse. The diameters are slightly different. In/Out markings are provided on each plugs.

When the coupler is pulled out the water pipe will be automatically blocked. Use cooling water corresponding to the specifications of Table 4.1 below.

Table 4.1 Industrial Water Supply Quality Specification

(Japan Industrial Water Association, Industrial Water Quality Standards Committee)

Turbidity	(ppm)	20
pH		6.5-8.0
Alkalinity(CaCO ₃)	(ppm)	75
Hardness(CaCO ₃)	(ppm)	120
Evaporation residue	(ppm)	250
Chlorine ion	(ppm)	80
Iron	(ppm)	0.3
Manganese	(ppm)	0.2

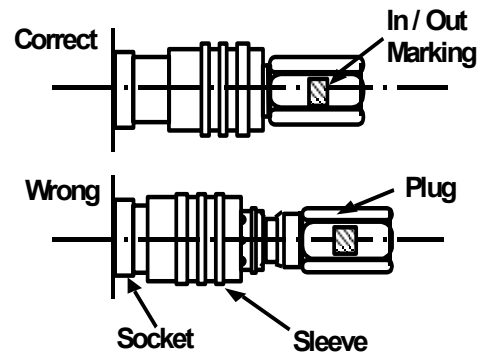

Fig. 4.2 Coupler



CAUTION

In the case of removing the coupler, at first close the valve of cooling water supply line and next remove the coupler from the cooling water supply.

In the case of connecting the coupler, connect it with the cooling water return (ret. outline drawing).

If the above is neglected, pressure in the cooling water piping rises rapidly and there is a possibility to cause the water leak.





CAUTION

Even when the cooling water flow rate drops, the pump will continue to operate until the pump part reach a temperature corresponding to the safety limit.

The material selected for the water piping of facility side should have a heat resistance so that it can withstand a maximum temperature of at least 70°C at the operating pressure.

 **CAUTION** When several pumps are used, be sure to connect the cooling water pipes to each pump in parallel. The cooling water will flow more or less easily according to the type of pump and the piping. Be sure to select the correct piping so as to ensure the appropriate cooling water flow rate for all pipes used.

 **CAUTION** When the cooling water connections are incorrect and the flow is reversed, a flow rate different from the normal value will be displayed. Pump may not be cooled properly under this condition, and this cause serious problem.
Be sure therefore to connect correctly to avoid problems.

 **CAUTION** When the cooling water supply is left on while the pump is stationary dew condensation will form on the water-cooled parts in locations with high humidity.
Make it a rule therefore to stop the cooling water when water droplets can be detected on the outer surface of the pump cooling water piping as this suggests the possibility of dew condensation in the pump.

4.2.3 N2 Gas Piping

Cut tube at right angles and make the end-face perfectly smooth. Then connect the tube to the tube fitting assembly of the N2 gas purge port. The tube is a push-fit onto the shoulder of the tube fitting assembly.

Secure the tube fitting assembly properly and tighten the retaining nut by hand. After this, use a tool to tighten the nut further by $1 + 1/4$ turns.

To connect the tube again after this, install the tube already fitted to the ferrule and re-tighten the retaining nut slightly after the initial tightening (generally, tighten by a further quarter turn after tightening by hand).

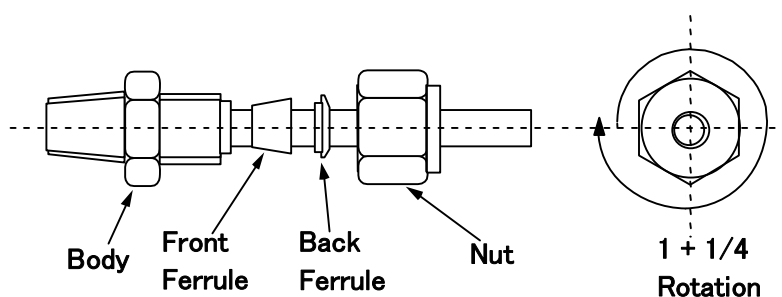

Fig. 4.3 Tube Fitting Assembly



CAUTION For safety, be sure to use N2 gas which purity is more than 99.999%. Impurities of N2 gas may cause an accident when the pump is used for exhausting toxic and/or inflammable gases.

4.2.4 Ventilation Duct

All dry pumps that Ebara supplies shall go through the leakage inspection after assembly regardless of the newly built or overhauled. Yet, in the cases where the user-supplied line connection at the pump exhaust outlet came out or the connection became loose due to long time pump operation while neglecting its maintenance may allow the hazardous gases to leak from the pump module.

This pump is designed such that the process gases will not leak to environment to the level harmful to human if the unit has been properly ventilated.

Proper ventilation is necessary not only to prevent the hazardous gases to leak but also release heat generated and accumulated in the pump module through the pump operation. Without proper ventilation, the temperature inside the cover will continue to rise until an ALARM is generated. This will result in serious problems.

Connect the ventilation duct, locating on the top of the pump, to a duct that the user provides. The user side duct shall have exhaust capability listed in Table 3.1 and shall be independent from the duct connected to the pump exhaust outlet.

A substance, which is not corroded with used gas, shall be used as the material of the exhaust duct.



CAUTION For safety, be sure to ventilate through the ventilation duct when the pump is used to exhaust toxic, inflammable, and/or other hazardous gases. Do not combine the ventilation duct with the pump exhaust piping



CAUTION Even when the pump is used for exhausting process gases that are not toxic and/or inflammable, do not combine the ventilation duct with the pump exhaust piping. The exhaust noise of the pump will give rise to acoustic resonance inside the pump unit and result in an abnormal noise being generated.



CAUTION Never operate the pump without pump cover for safety.

4.3 Electrical Wiring

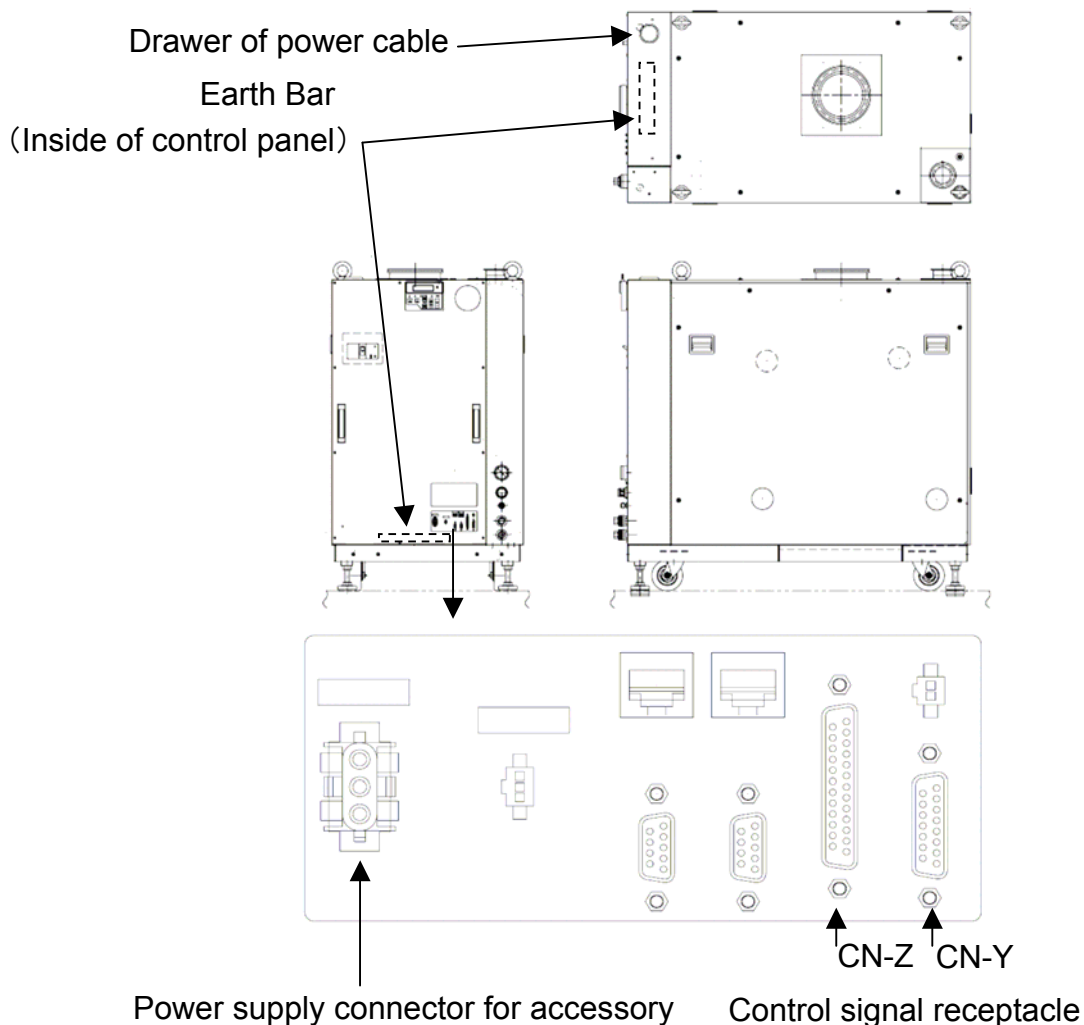

Fig.4.4 Location of drawer of power cable, control connector, and earth bar

! WARNING Be sure to keep the power supply to the pump turned off and lock-outed until you have finished the wiring and connecting work. Also interrupt the Earth Leakage Breaker (ELB) during this.

! WARNING Electrical wiring shall be carried out only by qualified electricians.

! CAUTION Do not apply the power supply from the pump's power pack to any other equipment as this will result in malfunctioning of the control units and in pump failure.

4.3.1 Grounding

This product should be grounded. In the event of an electrical short circuit, grounding reduces the risk of electric shock by providing an escape wire for the electric current. This product is equipped with a cord having a grounding wire with an appropriate grounding plug. The plug must be plugged into an outlet that is properly installed and grounded in accordance with all local codes and ordinances.

**DANGER**

Improper installation of the grounding plug can result in a risk of electric shock. If repair or replacement of the cord or plug is necessary, do not connect the grounding wire to either flat blade terminal. The wire with insulation having an outer surface that is green with or without yellow stripes is the grounding wire.

Check with a qualified electrician or serviceman if the grounding instructions are not completely understood, or if in doubt as to whether the product is properly grounded. Do not modify the plug provided; if it will not fit the outlet, have the proper outlet installed by a qualified electrician.

4.3.2 Power Supply Wiring

CAUTION Use the correct wiring materials and size to match the operating conditions in accordance with the power consumption rating and ambient air temperature of the pump.

CAUTION Be sure to connect the grounding wire.

CAUTION Wiring should be hard-wired or using twist-lock Hubbel type connector at power source side.

Wire the connector for the main power supply and grounding.

Fig. 4.4 and Tables 4.2 and 4.3 show the connector pin assignment.

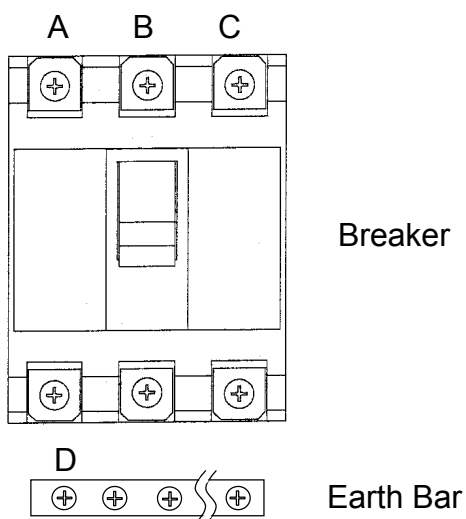

Table 4.2 Pin Assignment of Power Supply Terminal Block

No.	Phase
A	R
B	S
C	T
D	GND

Fig. 4.4 Power Supply Terminal Block
(As seen from connecting side)

Table 4.3 Terminal Block Specification

Pump Model	200V Model	460V Model
Adapted Terminal block	M8(R,S,T) M5(E)	
Torque with a bundle	(R,S,T) 8.0~13.0 [N·m] (E) 2.0~2.5 [N·m]	(R,S,T) 5.5~7.5 [N·m] (E) 2.0~2.5[N·m]
Suitable wire	AWG #2/0 *	AWG #4 *
Power capacity	41.3 kVA	

* Lengthen grounding wiring 1.2m from other wiring(R,S,T).

4.3.3 Control Signal Wiring

Connect wires to the control connector for remote operation and remote monitoring. Tables 4.4 , 4.5 , 4.6 and 4.7 and Figs. 4.6 and 4.7 show the pin assignment.

Table 4.4 Receptacle Specification

Connector No.	Connector type
CN-Z	15 pin D sub-miniature Female receptacle (Applicable for SEMI E73-0299)
CN-Y	25 pin D sub-miniature Female receptacle

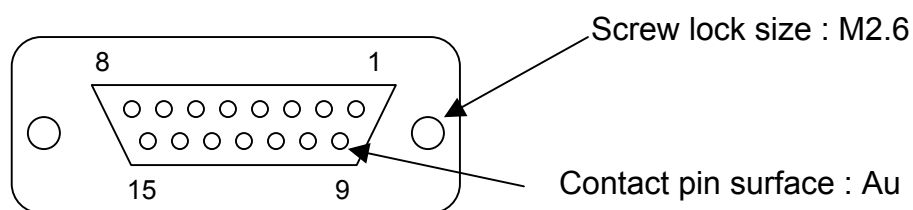

Fig. 4.5 15 Pin D Sub-Miniature Female Receptacle
(As seen from connecting side)

Table 4.5 Control Connector Pin Assignment(CN-Z)

Pin. No.	Signal name	I/O	Signal type
1	MP START (+)	IN	Run:CLOSE, Alternate
2	BP START (+)	IN	Run:CLOSE, Alternate
3	MP START STATUS (+)	OUT	Run:CLOSE, Alternate
4	BP START STATUS (+)	OUT	Run:CLOSE, Alternate
5	WARNING STATUS (+)	OUT	WARNING:OPEN, Alternate
6	ALARM STATUS (+)	OUT	ALARM:OPEN, Alternate
7	REMOTE STATUS (+)	OUT	REMOTE:CLOSE
8	-		
9	MP START (-)		
10	BP START (-)		
11	MP START STATUS (-)		
12	BP START STATUS (-)		
13	WARNING STATUS (-)		
14	ALARM STATUS (-)		
15	REMOTE STATUS (-)		

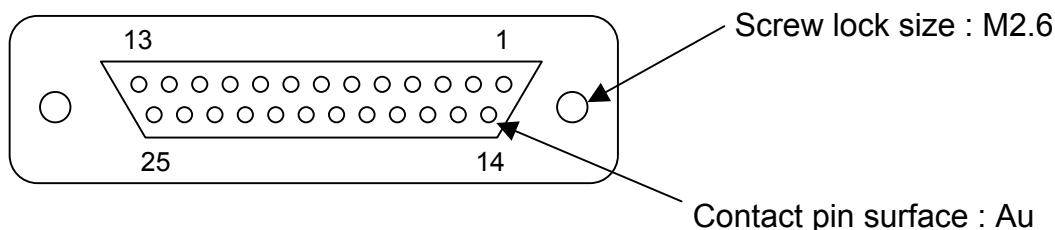

Fig. 4.6 25 Pin D Sub-Miniature Female Receptacle
(As seen from connecting side)

Table 4.6 Control Connector Pin Assignment(CN-Y)

Pin No.	Signal name	I/O	Signal type
1	RESET (+)	IN	RESET:CLOSE
2	LOW SPEED CONTROL (+)	IN	LOW SPEED:CLOSE, Alternate
3	RESERVED (+)	IN	
4	RESERVED (+)	IN	
5	RESERVED (+)	IN	
6	EMO STATUS (+)	OUT	Abnormality:OPEN, Alternate
7	PUMP N2 WARNING STATUS (+)	OUT	Abnormality:CLOSE, Alternate ※1
8	RESERVED (+)	OUT	
9	LOW SPEED CONTROL (+)	OUT	LOW SPEED:CLOSE, Alternate
10	BACK PRESSURE HIGH WARNING STATUS (+)	OUT	Abnormality:CLOSE, Alternate ※1
11	RESERVED (+)	OUT	
12	RESERVED (+)	OUT	
13	-		
14	RESET (-)		
15	SAVING ENERGY CONTROL (-)		
16	RESERVED (-)		
17	RESERVED (-)		
18	RESERVED (-)		
19	EMO STATUS (-)		
20	PUMP N2 WARNING STATUS (-)		
21	RESERVED (-)		
22	LOW SPEED CONTROL (-)		
23	BACK PRESSURE HIGH WARNING STATUS (-)		
24	RESERVED (-)		
25	RESERVED (-)		

※1 It can change to “Abnormality:OPEN, Alternate” by DIP SW. setting.

Table 4.7 CN-Z & CN-Y Signal Contacts

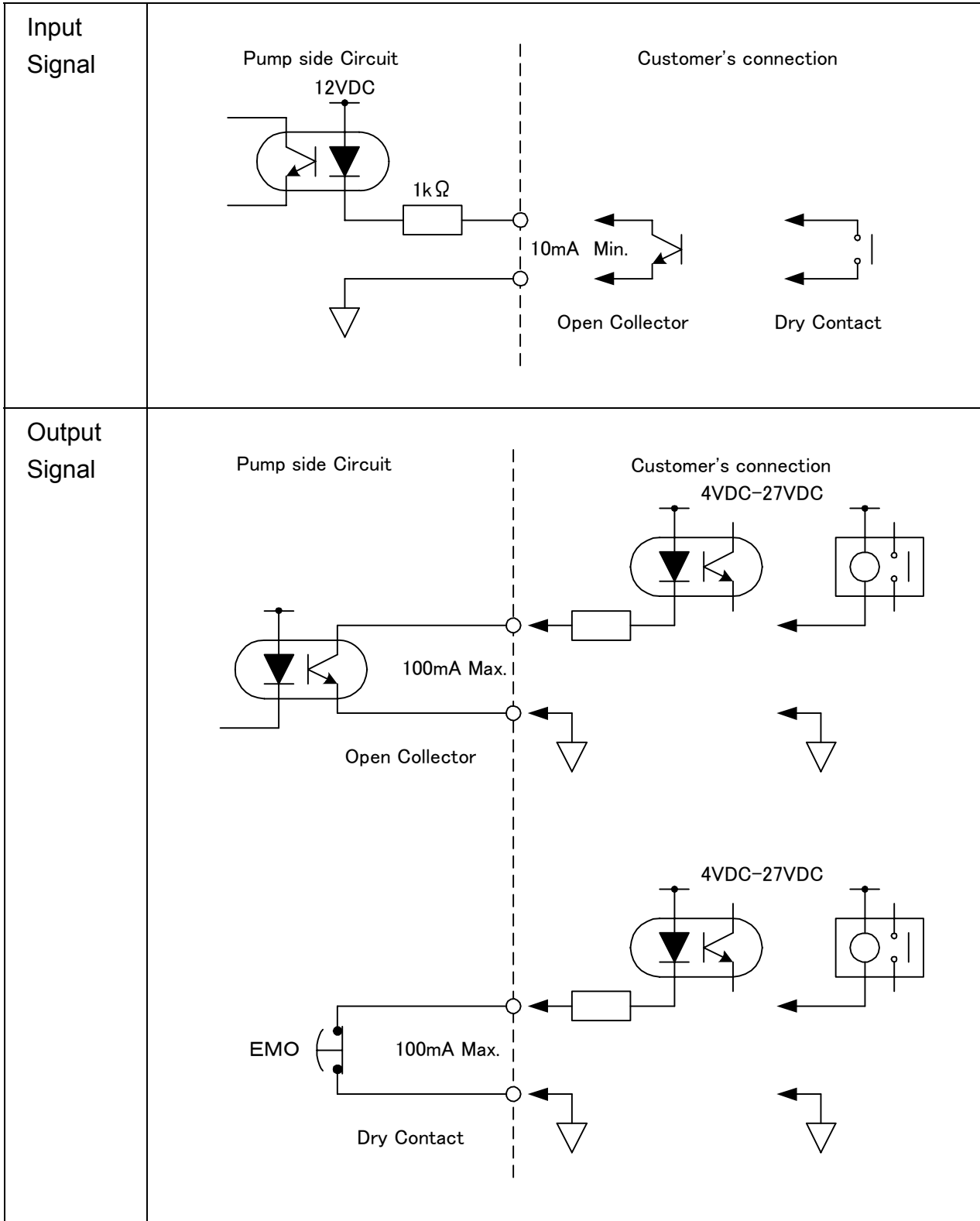

 **CAUTION** Do not wire vacant pins.

 **CAUTION** Apply a 12V DC power for input signals on the pump side.
Do not apply this voltage on the equipment side.
The output signals are generated from an open collector output.
Please use it by the equipment side, impressing the power supply of DC4V to DC27V.

 **CAUTION** Be sure to wire all signals with the correct polarity(SIG./COM.)

 **CAUTION** When output signals are used to energize an inductive load such as a relay, be sure to insert a diode (100V. 1A class) in order to absorb the back electromotive force due to surge currents.

5. Power Supply for accessories

Power supply connector for accessory is equipped beside main power supply connector. This power supply is used for standard option that is listed below.
(Shall not be used for other purposes.)

ADAPTER for Central Monitoring System
Interface Controller
N2 Solenoid Valve

 **DANGER** Power Supply for the options is kept applying voltage when Earth Leakage Breaker (ELB) turns on during the pump is supplied the power.

 **WARNING** Do not use the power supply for other purposes.

6. LCD Controller

6.1 LCD Outline

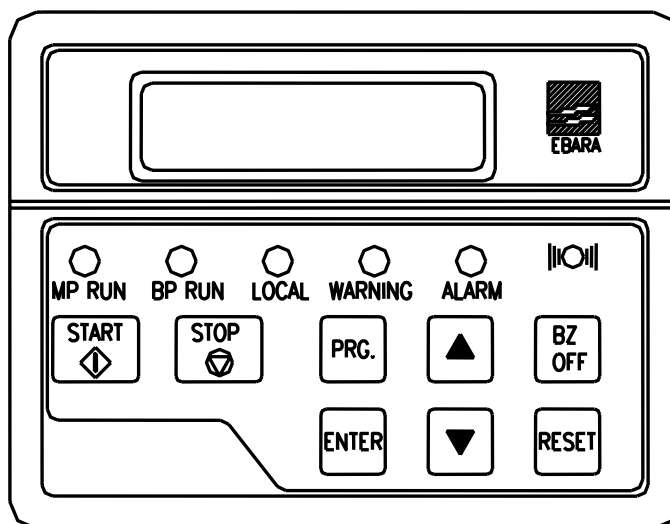

[Buttons]	START	For start Main pump(MP) and Booster pump(BP)
	STOP	For stop MP and BP
	▲ ▼	For changing LCD indication
	RESET	For resetting WARNING and ALARM
	BZ. OFF	For "buzzer mute in WARNING / ALARM "
	PRG.	For changing screen of pump status and change hierarchy of screen
	ENTER	For using at DIP switch selection and change hierarchy of screen
[LED]	B.P. RUN	BP running
	M.P. RUN	MP running
	LOCAL	LOCAL mode
	WARNING	WARNING condition
	ALARM	ALARM condition

Fig. 6.1 LCD controller

1. Three control modes are available : “LOCAL” (local operation) , “REMOTE” (remote operation) and “COM” (communication operation).
2. Two running modes are available “NORMAL” and “LOW SPEED”
3. " % " shows present number of WARNING/ALARM.
4. Upper row "\$\$\$\$\$\$" distinguishes between WARNING/ALARM and indicates the position where WARNING/ALARM has occurred.
Lower row "\$\$\$\$\$\$" displays details of WARNING/ALARM.
5. Total pump operating time gives the total hours of operation after shipment from the factory.
6. The display will return to the electrical power and motor rotation speed indication when no operation takes place after the lapse of 1 minute.
7. Use the Display Select Switch (Δ ∇) to change the display.
The WARNINGS/ALARMS that have currently been generated can be displayed with the Display Select Switch.

See Fig. 6.2 for the key operation of the pump operation status display.

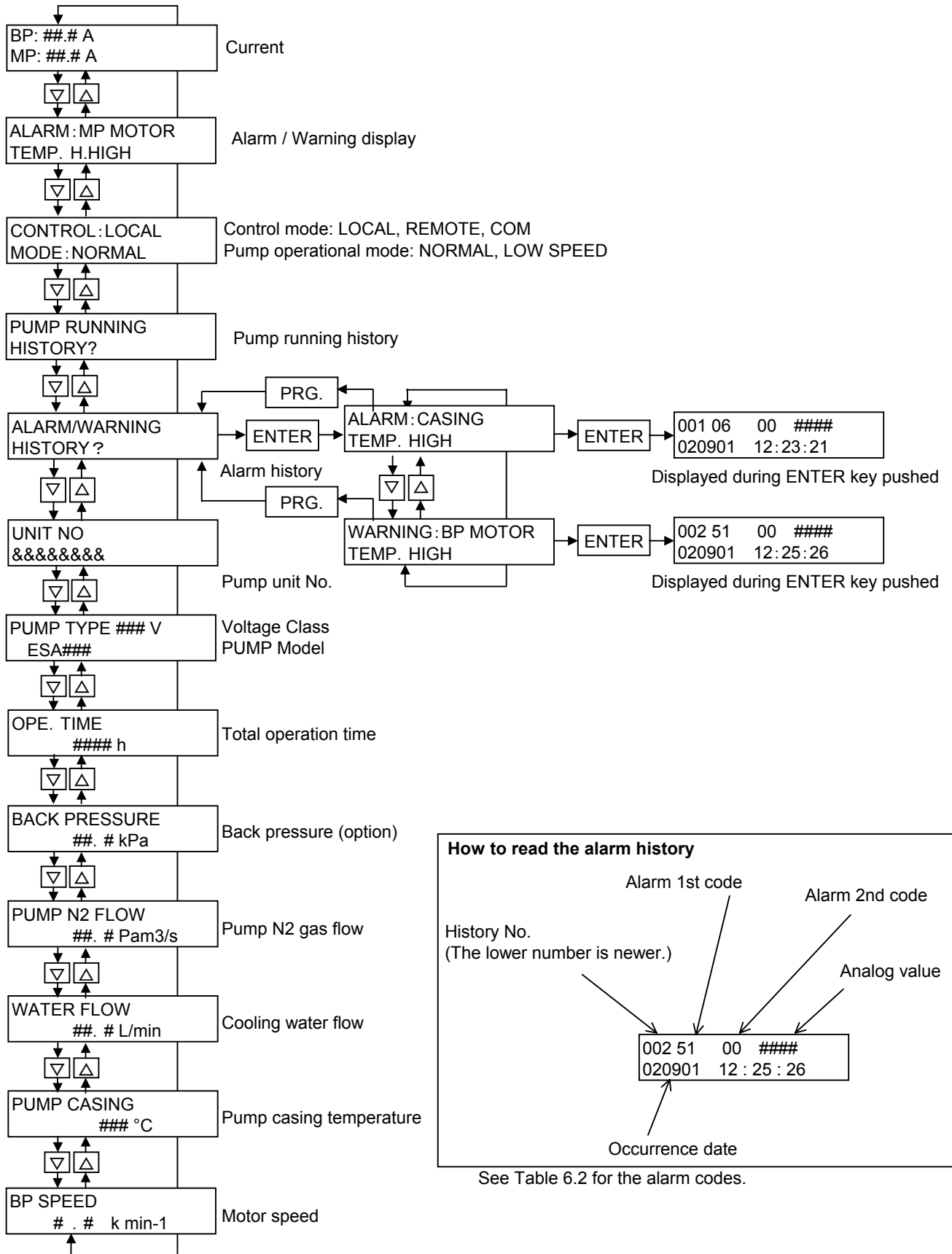

Fig. 6.2 Key operation for the pump operation status display screen

Table 6.2 Alarm code list

ALARM name	Code		
	1st code	2nd code	
MP casing temp high	50	01	
BP motor temp h. high	51	00	
MP motor temp h. high	52	00	
Water leakage (▲)	53	00	
BP motor overload	54	00	
MP motor overload	55	00	
MP no current	60	00	
Back press high (▲)	63	00	
Phase error	64	00	
BP driver OC	66	01	
BP driver OV		02	
BP driver OH1		04	
BP driver OH2		05	
BP driver CPF		06	
BP driver UV		07	
BP driver DRE		09	
BP motor overload 2		67	00
BP motor step out		69	00
Emergency off	71	00	
Water flow low	73	90	
Ext. interlock (▲)	74	00	
IO comm. error	81	01	
BP comm. error		02	
BP current high		03	

WARNING name	Code	
	1st code	2nd code
Water flow low	00	01
MP casing temp high	05	01
Pump box temp high	13	00
Pump N2 flow low	18	01
Back press high (▲)	21	01
Back press wire broke (▲)		02
BP motor temp high	23	00
MP motor temp high	24	00
BP driver temp high case	25	02
BP driver temp high inner		04
BP comm. error	26	02
IO comm. error		03
Current IO comm. error		07
BP current high	31	14

“▲” indicates that the item is optional.

Other error name	Code	
	1st code	2nd code
Watch dog timer error	47	00
Continuous alarm occurred!!	48	00
Momentary power failure running (*)	49	01
Momentary power failure stop (*)		02
Start fail alarm/warn exist		

“*” no displayed.

6.3 Setting the operational mode

This section describes how to set the operational mode. In the normal state, the LCD controller displays pump status. To display the operational mode setting screen, press the key “PRG.” for three seconds or longer. Pressing the key for one second or longer again returns to the pump status display screen. Table 6.3 below shows indications and the details of the operational mode setting.

Table 6.3 Operational mode setting screen

Item	Indication	Description
Setting the pump operation control mode	SET CONTROL MODE?	Switches the control modes: local ,remote, communication.
Setting the DIP switch	SET DIP SW?	Performs the DIP switch settings (see 6.4).
Setting the pump running mode	SET RUNNING MODE?	Switches the running modes: NORMAL and S. ENERGY.
Setting the rotational speed in the NOMAL mode	SET BP NOMAL SPEED?	Sets the pump rotational speed in the NOMAL mode.
Setting the rotational speed in the LOW SPEED mode	SET BP LOW SPEED?	Sets the pump rotational speed in the LOW SPEED mode.
Setting the pump N2 warning	SET POINT N2 FLOW LOW?	Sets the WARNING value for N2 flow
Setting the WARNING value for the back pressure (option)	SET POINT BACK PRESSURE?	Sets the WARNING value for the back pressure.

Keys work as below for the setting screen.

- START : Valid
- STOP : Stops the pump.
- RESET : Resets WARNING and /or ALARM.
- BZ.OFF : Switches the DIP switch No.
- △ : Sets the DIP switch to ON. Switches the display of the operational mode setting screen.
- ▽ : Sets the DIP switch to OFF. Switches the display of the operational mode setting screen.
- ENTER : Determines the selected setting.

See Fig. 6.3 for how to set the operational modes.

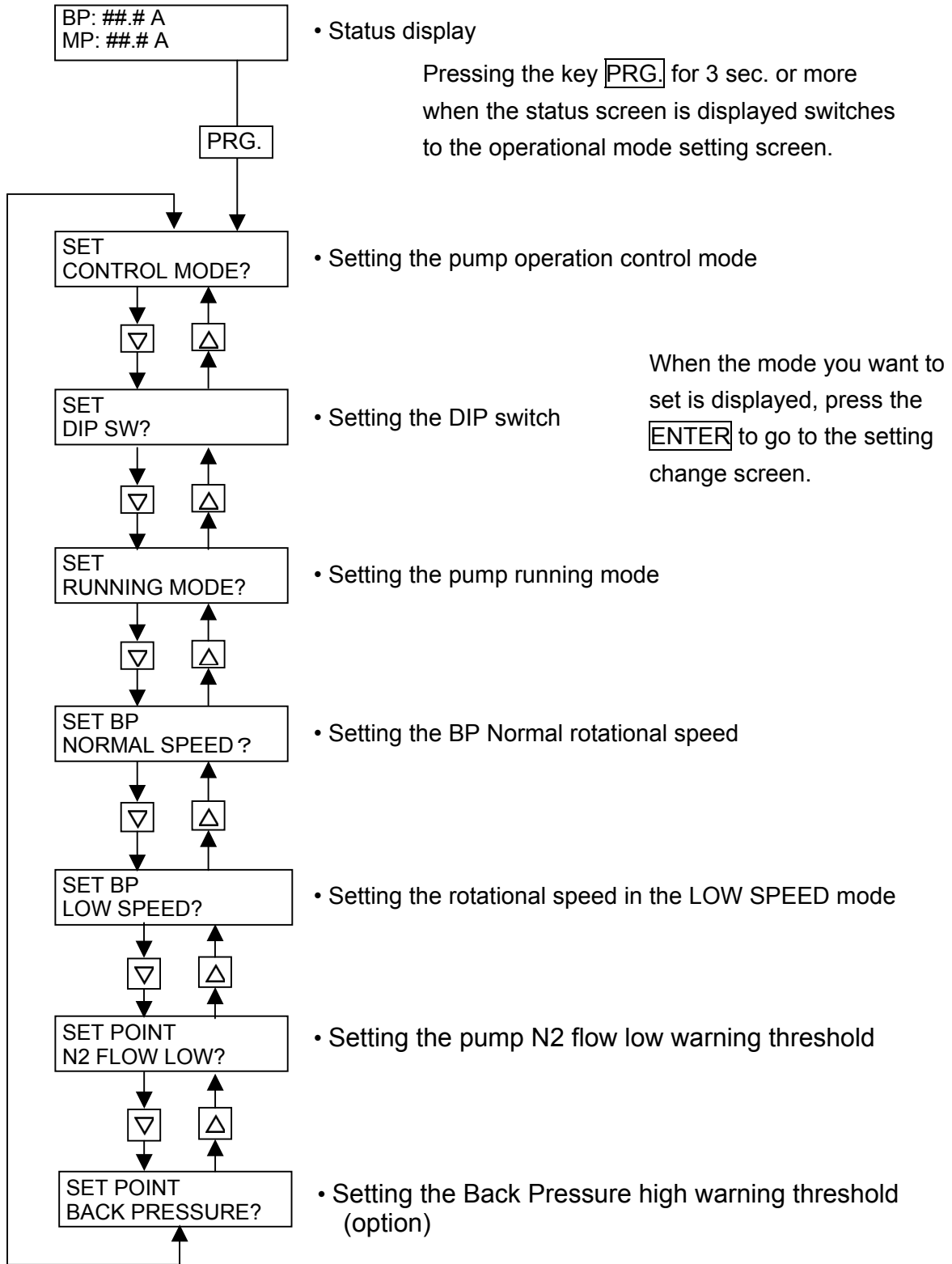
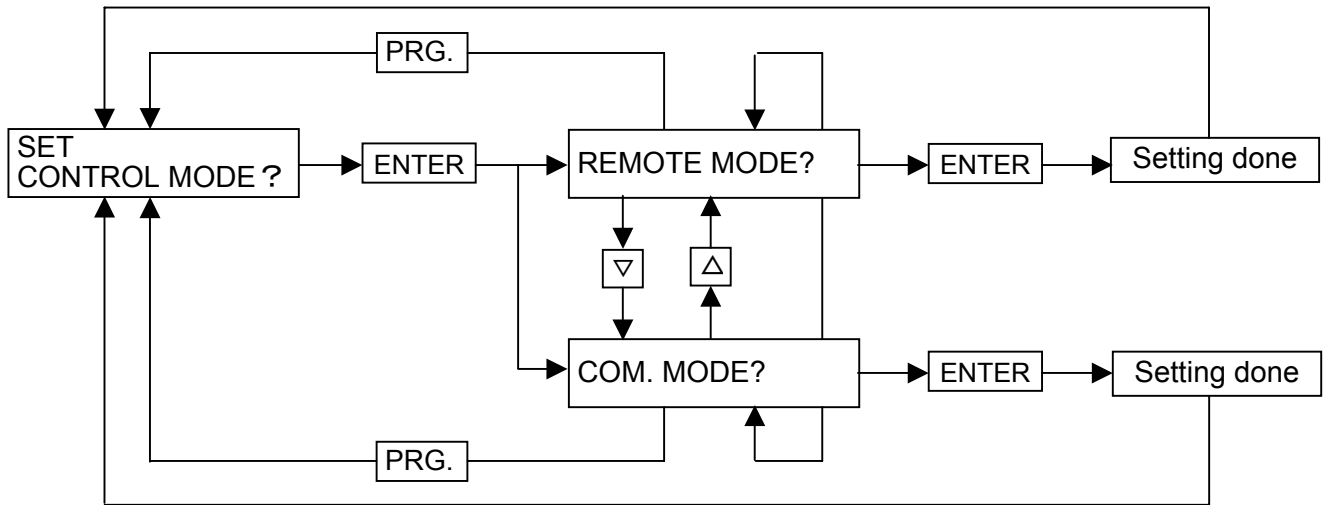

Fig. 6.3 How to set the operational mode

6.3.1 Setting the pump operation control mode

A case of display if Local mode selected.



- REMOTE MODE : Enables the remote operation
(start/stop with external signals)
- LOCAL MODE : Enables the local operation
(start/stop with the LCD controller)
- COM MODE : Enables the communication operation
(start/stop with RS232C communication)

The mode that is currently not set is displayed.

If you do not need to set, press **PRG.** key to go back to the previous screen.

6.3.2 Setting the DIP switch

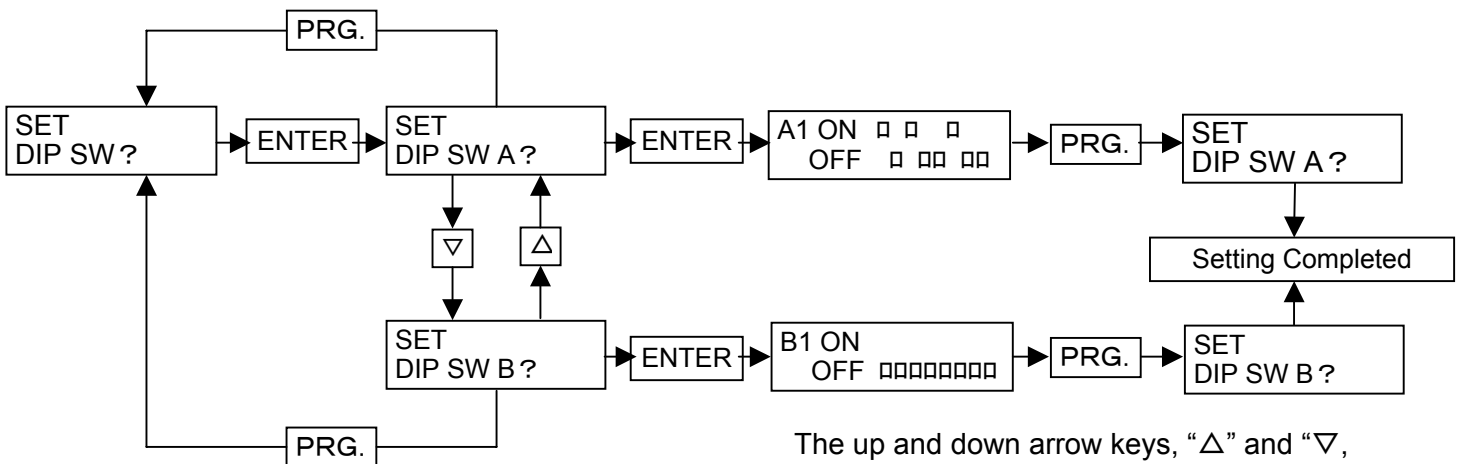

The up and down arrow keys, “△” and “▽,” turn On and OFF the DIP switch.
The key **BZ.OFF** switches the selection from 1 to 8.

See Section 6.4 for details of the DIP switch.

6.3.3 Setting the pump running mode

A case of display if Normal mode selected.

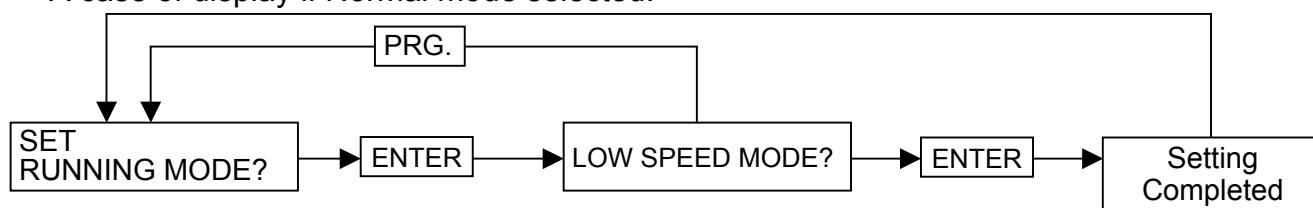

LOW SPEED MODE : Enables low speed operation

NORMAL MODE : Enables the rated operation.

The mode that is currently not set is displayed.

If you do not need to set, press **PRG.** key to go back to the previous screen.

6.3.4 Setting the BP normal rotational speed

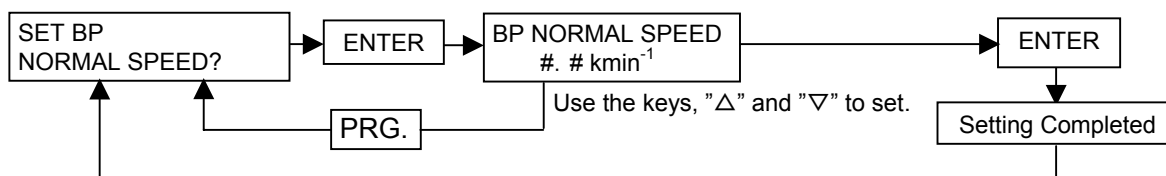

△ **▽** : Use the up and down arrow keys to change the setting value.

△ : Increase the setting speed by 0.1 kmin⁻¹.

▽ : Decrease the setting speed by 0.1 kmin⁻¹

Upper limit : 7.0 kmin⁻¹

Lower limit : 3.0 kmin⁻¹

Factory Setting : 7.0 kmin⁻¹

6.3.5 Setting the rotational speed in the LOW SPEED mode

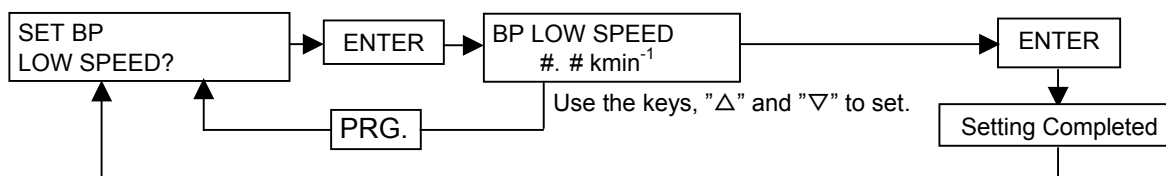

△ **▽** Use the up and down arrow keys to change the setting value.

△ : Increase the setting speed by 0.1 kmin⁻¹.

▽ : Decrease the setting speed by 0.1 kmin⁻¹

Upper limit : 7.0 kmin⁻¹

Lower limit : 1.0 kmin⁻¹

Factory Setting : 3.0 kmin⁻¹

6.3.6 Setting the pump N2 flow

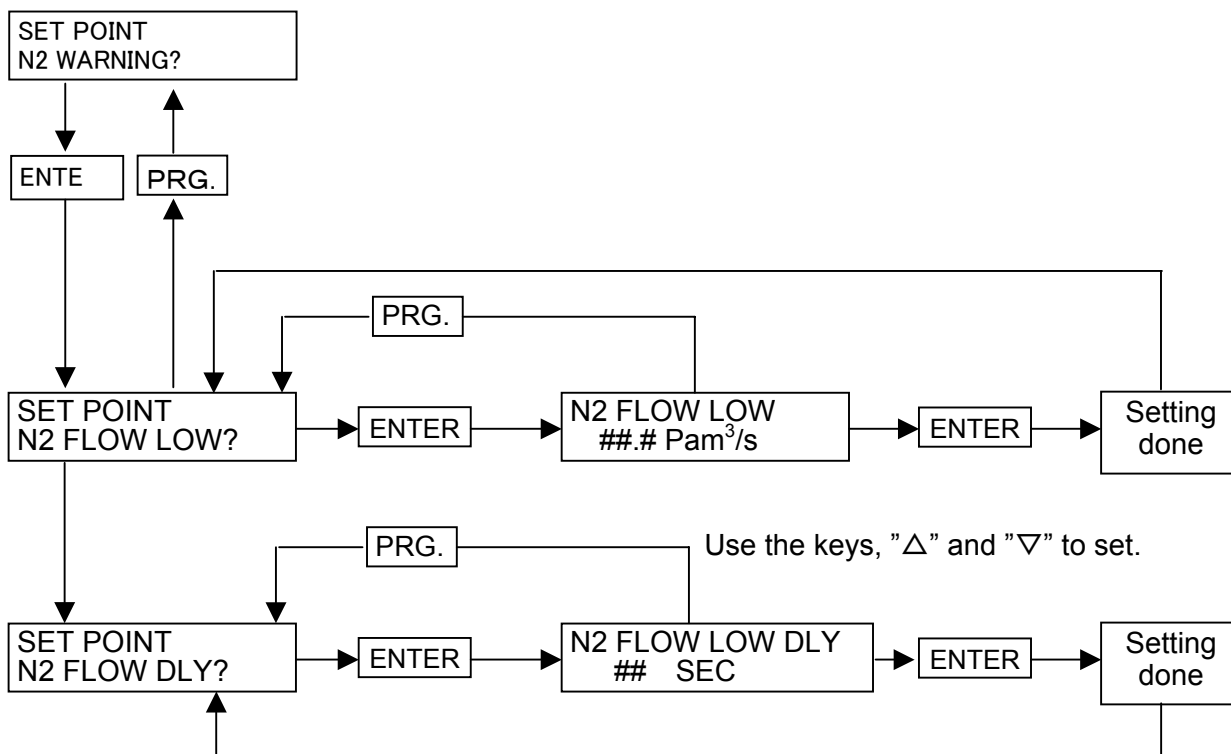

- Use the up and down arrow keys to change the setting value.
 Δ : Increase the setting speed / delay time by 0.1 Pam³/s or sec
 ▽ : Decrease the setting speed / delay time by 0.1 Pam³/s or sec
 Upper limit : 81.0 Pam³/s , 60 sec
 Lower limit : 2.2 Pam³/s , 5 sec
 Factory Setting : 5.0 Pam³/s , 60 sec
 (Reset value for WARNING set value of flow low: +1.0 Pam³/s)

6.3.7 Setting the WARNING value for the back pressure (option)

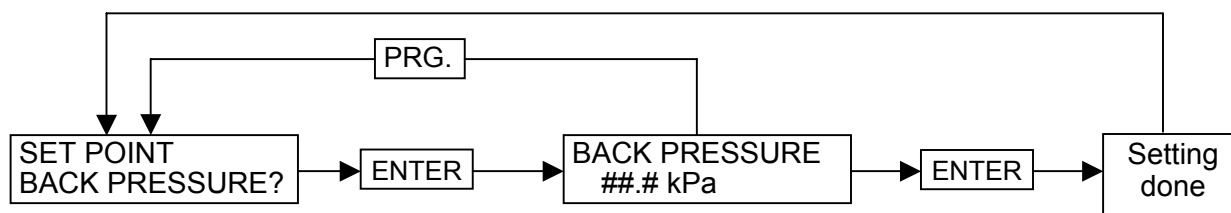

Use the keys, "△" and "▽" to set.

△ ▽ Use the up and down arrow keys to change the setting value.

△: Increase the setting value by 0.5 kPa.

▽ : Decrease the setting value by 0.5 kPa.

Upper limit : 20.0 kPa

Lower limit : 5.0 kPa

Factory setting : 10.0 kPa

WARNING reset value : Set value -2.0 kPa

6.4 Dip Switch

Set the dipswitches to select the operating modes as shown in Table 6.4, 6.5 and 6.6.

Table 6.4 Dip Switch-A Settings

No.	Mode	Off	On	Factory setting
1	Data Length	7bits	8bits	ON
2	Monitor Cooling water and N2	Always	Only during operation	OFF
3	Buzzer	Not used	Use	ON
4	Operation switched to Remote	According to signal	Automatically stop	OFF
5	External start/stop signal *	Alternate (Level)	Momentary (Pulse) *	OFF
6	----	----	----	----
7	----	----	----	----
8	BP operation in Remote	Automatic operation	External signal input	OFF

* Optional

Table 6.5 Dip Switch-B Settings

No.	Mode	Off	On	Factory setting
1	----	----	----	----
2	----	----	----	----
3	----	----	----	----
4	Pump N2 valve control*	No	Yes	OFF
5	----	----	----	----
6	Remote Interface (IF)	Exclusive special IF	No use / standard IF	ON
7	Phase error monitoring	Standard	During starting only	OFF
8	LCD screen initialize	Carry out initialize	Do not initialize	OFF

* Optional

Table 6.6 Dip Switch-C Settings

No.	Mode	Off	On	Default
1	Outputs the pump N2 warning.	Normal Open	Normal Close	OFF
2	----	----	----	----
3	Outputs backpress. warning. *	Normal Open	Normal Close	OFF
4	----	----	----	----
5	----	----	----	----
6	----	----	----	----
7	----	----	----	----
8	----	----	----	----

* Optional

DIP SW-A. No.1 In case of observing pump running status with RS232C communication port, Data Length can be selected out of 7bits and 8bits.

-
- DIP SW-A. No.2 Sets the monitoring mode for the cooling water and N2: "Always" or "During operation only."
In the mode "During operation only" for the cooling water, the monitoring continues for 15 minutes after operation stop for cooling the pump.
It is recommended that N2 purge should be continuously active during operation stoppage to reduce by-product accumulation and corrosion in the pump.
- DIP SW-A. No. 3 Dip switch-A No. 3 lets you select whether an acoustic alarm (buzzer) should be sounded or not when a WARNING/ALARM signal has been generated.
- DIP SW-A. No. 4 When the toggle switch is moved from the LOCAL to the REMOTE position, dip switch-A No.4 lets you select "PUMP START/STOP in Response to External Start Signal (According to Signal)" or "PUMP STOP Regardless of External Signal (PUMP STOP)".

[NOTE] Dip switch-A No.3 (BUZZER) and Dip switch-B No.8 (LCD initialize) can change always. When parameter setting of the dip switches, other than dip switch-A No.3 (BUZZER), is performed, the LCD controller counts down 10 seconds, the same as at the power on state, right after the completion of the parameter setting.

- DIP SW-A. No. 5 Dip switch-A No. 5 lets you select "ALTERNATE Signal (START Signal ON/OFF)" or "MOMENTARY Signal (2 types of signal: ON or OFF)" for pump start and stop under external signal control.

[NOTE] When there is no special interface for ESA, you cannot select "MOMENTARY Signal". When there is this special interface for ESA, you can select "MOMENTARY Signal" or "ALTERNATE Signal".

- DIP SW-A. No. 8 When dip switch-A No. 8 has been set to the REMOTE (Remote Operation) position, it is possible to operate the Booster Pump (BP) by selecting "AUTOMATIC Operation" or "START/STOP in Response to External Signal Input."

- DIP SW-B. No.4 Controls N2 supply to the pump with a valve attached to the N2 piping in the pump unit. This is optional.
- DIP SW-B. No.6 Activate or inactive the special interface for ESA.
- Set this to OFF to activate the interface (optional).
 - Set this to ON to inactivate the interface (default).
- DIP SW-B. No.7 Selects the detection method for phase loss in the power source.
- DIP SW-B. No.8 Locks or unlocks the currently selected operation status display, which usually returns to the power display in 60 seconds.
- DIP SW-C. No.1 This switch allows you to select "NORMAL OPEN" or "NORMAL CLOSE" for PUMP N2 WARNING output.
- DIP SW-C. No.3 This switch allows you to select "NORMAL OPEN" or "NORMAL CLOSE" for Backpressure WARNING output.

 Characters displayed on LCD screen during dip switch setting

Dip switch A

No.	MODE	OFF	ON
1	Length of communication data	A1:DATA LENGTH 7BIT	A1:DATA LENGTH 8BIT
2	Monitor condition of cooling water / Nitrogen	A2:WATER&N2 WATCHING ALWAYS	A2:WATER&N2 ONLY RUNNING
3	Buzzer	A3:BUZZER INACTIVE	A3:BUZZER ACTIVE
4	Remote/Local setting	A4:REM. ACTION CONCORD	A4:REM. ACTION STOP
5	Type of Input signal *	A5:REM. SIGNAL ALTERNATE	A5:REM. SIGNAL MOMENTARY*
6	----	A6:NO ASSIGNED	A6:NO ASSIGNED
7	----	A7:NO ASSIGNED	A7:NO ASSIGNED
8	BP operation under REMOTE mode	A8:BP REM. MODE AUTO	A8:BP REM. MODE EXTERNAL INPUT

Dip switch B

No.	MODE	OFF	ON
1	----	B1:NO ASSIGNED	B1:NO ASSIGNED
2	----	B2:NO ASSIGNED	B2:NO ASSIGNED
3	----	B3:NO ASSIGNED	B3:NO ASSIGNED
4	----	B4:NO ASSIGNED	B4:NO ASSIGNED
5	----	B5:NO ASSIGNED	B5:NO ASSIGNED
6	Remote Interface	B6:REMOTE I/O OPTION	B6:REMOTE I/O STANDARD
7	Phase error monitoring	B7:PHASE ERROR STANDARD	B7:PHASE ERROR COUNTDOWN ONLY
8	LCD screen initialize	B8:LCD DISPLAY INITIALIZING	B8:LCD DISPLAY UN-INITIALIZING

Dip switch C

No.	MODE	OFF	ON
1	PumpN2 Warning output	C1:PUMP N2 WARN OUTPUT N.OPEN	C1:PUMP N2 WARN OUTPUT N.CLOSE
2	----	C2:NO ASSIGNED	C2:NO ASSIGNED
3	Back Pressure Warning output	C3:BACK PRES. OUTPUT N.OPEN	C3:BACK PRES. OUTPUT N.CLOSE
4	----	C4:NO ASSIGNED	C4:NO ASSIGNED
5	----	C5:NO ASSIGNED	C5:NO ASSIGNED
6	----	C6:NO ASSIGNED	C6:NO ASSIGNED
7	----	C7:NO ASSIGNED	C7:NO ASSIGNED
8	----	C8:NO ASSIGNED	C8:NO ASSIGNED

* Optional

6.5 Dip Switch setting display

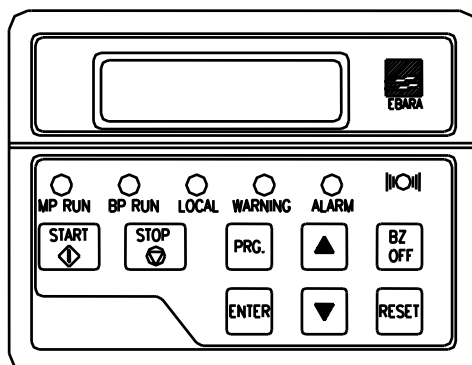

Fig 6.4 LCD controller

Key functions will be as follows on the setting display.

- START : Invalid
- STOP This stops pump operation.
- RESET This resets trip and alarm.
- BZ.OFF This switches the dip switch numbers.
- ▲ This sets the selected dip switch ON.
- ▼ This sets the selected dip switch OFF.
- ENTER This indicates the next page of the display.

DIP Switch-A

A*	ON						
	OFF	<input type="checkbox"/>	<input type="checkbox"/>	<input type="checkbox"/>	<input type="checkbox"/>	<input type="checkbox"/>	<input type="checkbox"/>

DIP Switch-B

B*	ON						
	OFF	<input type="checkbox"/>	<input type="checkbox"/>	<input type="checkbox"/>	<input type="checkbox"/>	<input type="checkbox"/>	<input type="checkbox"/>

DIP Switch-C

C*	ON						
	OFF	<input type="checkbox"/>	<input type="checkbox"/>	<input type="checkbox"/>	<input type="checkbox"/>	<input type="checkbox"/>	<input type="checkbox"/>

* indicate the dip switch number (1 to 8) currently you are setting.

Fig 6.5 DIP Switch

[NOTE] Duration of pump operation, dip switches, except A-3 (BUZZER) and B-8 (LCD initialize), can not be used for parameter setting.

[NOTE] When parameter setting of the dip switches, other than dip switch-A No.3 (BUZZER) and B-8 (LCD initialize), is performed, the LCD controller counts down 10 seconds, the same as at the power on state, right after the completion of the parameter setting.

[NOTE] If any warning or alarm occurs during the parameter setting, the setting session will be stopped automatically and the display will be changed to the warning & alarm display screen.

6.6 Starting/stopping the pump with the LCD controller

Maximum two LCD controllers can be connected. Note only one of them can start and stop the pump (the other shows the pump operational statuses). The controller of which LED "LOCAL" is lit on has precedence over the other to control the start and stop operation.

If only one controller is connected, the controller starts and stops the pump.

	One controller connected	Two controller connected
START/STOP	Allowed	The one with its LED "LOCAL" lit on is allowed.

When you use two controllers, disconnect the one which you will not use for the operation from the pump once. Then, attach it again.

7. Operation

7.1 Before Starting

- (1) Turn on the cooling water supply and check that there are no leaks at the pipe connections.

 **CAUTION** Without sufficient cooling water, the pump temperature will rise and problems such as rotor contact will occur.

[**NOTE**] The pump unit itself has no cooling water flow adjustment valve.

- (2) Turn on the N2 gas supply.

Check that the regulator attached to the pump is closed. (It is closed when the pressure adjustment knob is fully turned in the counterclockwise direction.) Open the main valve and check that there are no N2 gas leaks from the pipe connections.

Slowly turn the pressure adjustment knob clockwise to set the pressure (gauge pressure) to 0.1 MPa first. Then press the red stopper to lock the knob in position.

 **WARNING** Be sure to purge with N2 gas in order to prevent corrosion and reduce the formation/deposition of reaction by-products in the pump. When inflammable and/or toxic gases are diluted with N2 to the safe concentration, be sure to maintain a separate supply of N2 gas to the pump exhaust pipe.

 **CAUTION** Abrupt rotation of the pressure adjustment knob will cause the pressure indicator needle of the regulator to wobble and result in an inaccurate pressure display.

 **CAUTION** Unless a sufficient supply of N2 gas is maintained, serious problems will occur such as oil back flow or pump corrosion and accretion of reaction by-products.

-
- (3) Turn on the power supply to the pump.
 - (4) The LCD controller counts down 10 seconds after placing the Earth Leakage Breaker (ELB) into the ON position.

[NOTE] The pump cannot start while the measuring instruments are warming up for 10 seconds after the ELB is placed in the ON position.

- (5) Check on the WATER FLOW display of the LCD Controller that the cooling water flow rate is 6 L/min. or more.
- (6) Re-check on the PUMP N2 FLOW display of the LCD Controller that the dilution N2 gas flow rate is within the 8.5~11.0 Pam³/s range. Also check that the pressure gauge shows a reading of 0.09 - 0.12MPa.
- (7) When the WARNING/ALARM display appears on the LCD controller or when any abnormal symptoms are found other than the display, take action in accordance with 10. "Troubleshooting."
Even when the cause of the WARNING/ALARM display has been removed, it is maintained until the RESET signal is entered. Either press the RESET button or enter an external RESET signal from the control signal connector. In the BUZZER Enabled mode using Dip switches, it is possible to stop the buzzer by pressing the "BZ.OFF" button when the alarm is being generated.
- (8) When the pump exhaust pipe is equipped with a valve, open this valve before starting the pump.

**CAUTION**

Problems will occur when the pump is operated with the valve closed as the exhaust pipe will be pressurized.

7.2 START/STOP

The DIP switches can be set at any time to select the REMOTE/LOCAL modes and BUZZER Enabled function. Set in accordance with the operating conditions. (See 6.3. Setting the operational mode.)

**WARNING**

The pump and exhaust piping will remain at a high temperature during operation and for a short time after the pump has stopped.

Be sure to avoid contact and keep inflammable substances out of reach.

Do not remove the outer cover during operation.

**CAUTION**

When the production process leads to react by-products in the pump or when the process handles corrosive gases, be sure not to stop the pump until after at least 30 minutes of stopping the process gases.

**CAUTION**

Process gases will remain in the vacuum pipes and the pump even after the pump has been stopped.

Be sure that therefore to purge for at least 1 hour after the pumps has been stopped.

Do not discontinue the N₂ purge when the pump is stopped only for a short time.

**CAUTION**

The pump will remain at a very high temperature event after it has been stopped. Be sure therefore to leave the cooling water on for about 1 hour after the pump has been stopped.

[NOTE] It will take approx. 30 min. to reach the prescribed ultimate pressure when pump starts under the state of cold start.

[NOTE] Do not exhaust the process gases until at least 30 minutes after the pump has been started. The pump casing temperature will stabilize after about 4 hours and it is recommended not to start exhausting the process gases earlier than this.

[NOTE] Do not restart the pump until 30 seconds past, after the pump was stopped. The alarm(OVERLOAD2, STEP OUT, DRIVER ALARM) may generate if the pump is started during the time.

When DIP switch-A No. 4 is placed into the ON position and the toggle switch is changed from the LOCAL to the REMOTE setting the pump will stop regardless of the external signal input.

7.2.1 LOCAL Start/Stop

a) START

Press the START button on the controller.

The Main Pump (MP) will start and the M.P. RUN lamp on the controller will light.

After this, the Booster Pump (BP) will start automatically and the B.P. RUN lamp on the controller will light.

The current is indicated on the display during pump operation.

For other status display indications, refer to Table 6.1.

[NOTE] The pump will not start when an WARNING/ALARM has been generated. When the START button is pressed, "STARTFAIL" will appear on the display.

b) STOP

Press the STOP button on the controller. The MP and BP will stop simultaneously.

The RUN lamp goes out and the display gives a power reading of 0.0A.

7.2.2 REMOTE Start/Stop

a) START

Enter the external "MP" start signal input from the control connector.

The MP starts.

In the automatic BP operating mode, the BP can be started/stopped automatically.

When the BP is operated under external start signal input, apply the external BP start signal to the control connector.

The current is indicated on the display during pump operation. For other status display indications, refer to Table 6.1.

[NOTE] The pump will not start when a WARNING/ALARM has been generated. When a START signal is entered, "STARTFAIL" will appear on the display.

b) STOP

Interrupt the external MP start signal and the pump will stop.

7.2.3 COMMUNICATION Start/Stop

a) START

Enter the external "MP" start signal input through the communication connector.
The MP starts.

In the automatic BP operating mode, the BP can be started/stopped automatically. When the BP is operated under external start command input, apply the external BP start command to the communication connector. The power is indicated on the display during pump operation. For other status display indications, refer to Table 6.1.

[NOTE] The pump will not start when an ALARM/WARNING has been generated. When a START signal is entered, "STARTFAIL" will appear on the display. BP can be started/stopped by the external signal when the DIPswitch set accordingly.

b) STOP

Interrupt the external MP start command and the pump will stop.

*Please refer to the COMMUNICATION SPECIFICATIONS in detail.

8. Maintenance and Inspection

8.1 Internal energies

Following items show internal energies that shall be considered before start service maintenance.

8.1.1 Power source

This dry pump is supplied with AC200V power source. Aside from the pump, the accessory power source locating in the vicinity of the power connectors are supplied with voltage even when the pump is completely stopped. To conduct pump maintenance or service, be sure to turn off the breaker switch, lock it out and then unplug the power cable. Refer to Section 3.4 in this manual for locking out the breaker switch.

8.1.2 Cooling water

This dry pump is supplied with cooling water at pressure of maximum 0.4 MPa. Disconnection of the cooling water resulted from improper handling may cause electrification and unit damage. For service and transportation, unplug the cooling water connection plugs on the inlet and outlet, and seal off with plastic cap. The self-sealing plug is used for the cooling water connection plug in these pumps.

8.1.3 N2 gas

This dry pump is supplied with N2 gas at pressure of maximum 0.7 MPa for diluting and sealing inside the pump. For service and transportation, close the supply-source valve to reduce the pressure with the regulator and detach the gas connection. Close N2 port with blank off plug. If the pump has already operated with process gases, purge the residual gases with N2 gas after stopping the pump operation. Then, conduct maintenance.

8.2 Routine Inspection

Check periodically that WARNING signal is not output on the LCD controller or remote output.

Table 8.1 Typical check items

No.	Item	Sensor	Interval (recommended)
1	Motor Current	Current Transformer	Every 1 week
2	N2 Gas Flow	Flow sensor	
3	Vibration / Noise	-----	
4	Cooling water flow	Flow sensor	
5	Pump casing Temp.	Thermo- Couple	
6	Color / level of lubricant oil	-----	Every 1 month

When the WARNING/ALARM display appears, take action in accordance with Section 10. "Troubleshooting."

If the lubrication oil amount is lower than the lower limit line of the oil level gauge, supply the lubrication oil. See the Section 8.4 "Lubrication oil" when adding the oil.



WARNING

Switch off the power supply to the pump first and interrupt the Earth Leakage Breaker (ELB) and lockout before you start on maintenance.



WARNING

The pump and exhaust piping will remain at a high temperature during operation and for a short time after the pump has stopped.

Be sure to avoid contact and keep inflammable substances out of reach.

Do not remove the outer cover during operation.

Even when the cause of the WARNING/ALARM signal has been removed the signal will be maintained until the "RESET" signal is entered. After you have taken the remedial action, press the "RESET" button on the controller or enter the RESET signal from the control signal connector to reset the WARNING.

 **CAUTION** The pump will not stop when a WARNING signal is generated. When pump operation is continued in this condition an ALARM signal will be generated or a serious breakdown will occur. Be sure therefore to check the pump in accordance with the instructions of Section 10. "Troubleshooting" after the process plant has completed 1 cycle.

 **CAUTION** When an ALARM signal has been generated in the REMOTE operating mode, do not start the maintenance tasks until you have interrupted the external start signal. When the external ALTERNATE start signal input is maintained, the pump will start while the ALARM is being reset.

If any abnormal symptoms other than those displayed on the LCD controller appear, take action in accordance with the instruction of Section 10. "Troubleshooting".

When the "BZ.OFF" button is pressed in the BUZZER Enable mode, the buzzer will stop even during an warning status.

8.3 Vacuum and Exhaust Piping

 **WARNING** Maintenance on the vacuum and exhaust piping shall be performed by taking proper action to avoid the dispersion of inflammable, toxic and/or hazardous substances and to prevent physical contact with, and absorption of, these substances.

 **WARNING** The pump and exhaust piping will remain at a high temperature during operation and for a short time after the pump has stopped.

Be sure to avoid contact and keep inflammable substances out of reach.

Do not remove the outer cover during operation.

 **WARNING** Be sure to check for gas leaks after you have finished pipe maintenance work. Leaks will cause serious danger due to the discharge of harmful and hazardous substances and the occurrence of unpredictable reactions associated with the admission of air into the pump. When checking for gas leaks by pressurization, please pressurize by less than 0.05 MPa into the purge port and do check.

Toxic gases may be generated from by-products in the piping or pump in pump disconnection from the tool piping for repair and replacement or flange removal for maintenance. Gain relevant information about the process gases from your tool suppliers, and be sure that the gas concentrations in the work areas are at quarter or under the acceptable values specified using appropriate measurement equipment.

Without assurance of gas safety, instruct the workers to wear proper personnel protective equipment if necessary to protect them from gas hazards. The personnel protective equipment must include at least gloves, safety goggles, and a gas mask.

Be sure to following the instructions below when carrying out maintenance work on the vacuum and exhaust piping of the pump.

- (1) Before you remove and wash the piping be sure to purge with a sufficient volume of N₂ gas.
- (2) When an exhaust gas scrubber unit is used, close the inlet valve of the exhaust gas scrubber after the N₂ gas purge has been discontinued and then remove the piping.
- (3) Be sure to switch off the power supply.
- (4) After you have washed the piping do not reconnect until it has dried completely.

8.4 Lubricant Oil

! CAUTION Do not start filling oil until the interior pump pressure has reached atmospheric pressure. The chamber containing the oil is under low pressure (vacuum) so that a significant leak will occur causing substantial damage to the pump when the oil-filling plug is removed with the pump operating.

! CAUTION Waste oil shall be disposed of by industrial waste disposal dealer in accordance with Material Safety Data sheets. (appendix1, 2)

If the oil level is lower than the lower limit line of the oil level gauge in daily inspection and maintenance, it is necessary to supply oil.

Follow the steps below to supply oil.

- (1) Stop the pump and remove the outer side cover on the pump. (See Fig. 8.1)

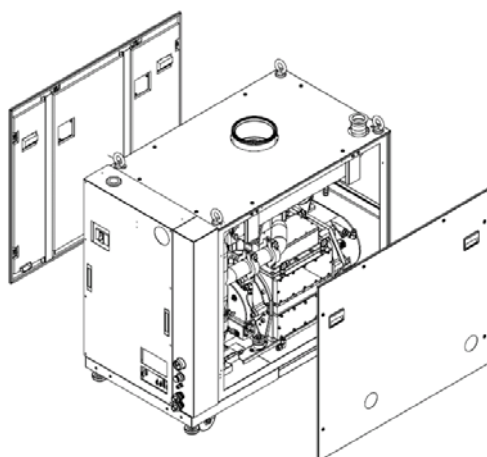

Fig. 8.1 How to remove pump covers

- (2) After you have waited until the internal pump pressure returns to atmospheric (normal) pressure, remove the plug from the oil-filler inlet. (See Fig. 8.2)
- (3) Check the level through the window of the gauge. Then, add the oil so that the level is upper limit line (see Fig. 8.2 and 8.3).
- (4) After you have checked that there are no depositions and fragments adhering to the O ring attached to the plug, close the oil-filler inlet.
- (5) Fit a waste oil container (PVC bag) to the bottom of the oil drain hole of the secondary reservoir and remove the drain plug. (See Fig.8.2)
- (6) When you have drained off the waste oil close the drain hole after you have checked that there are no depositions and fragments adhering to the O ring attached to the plug.

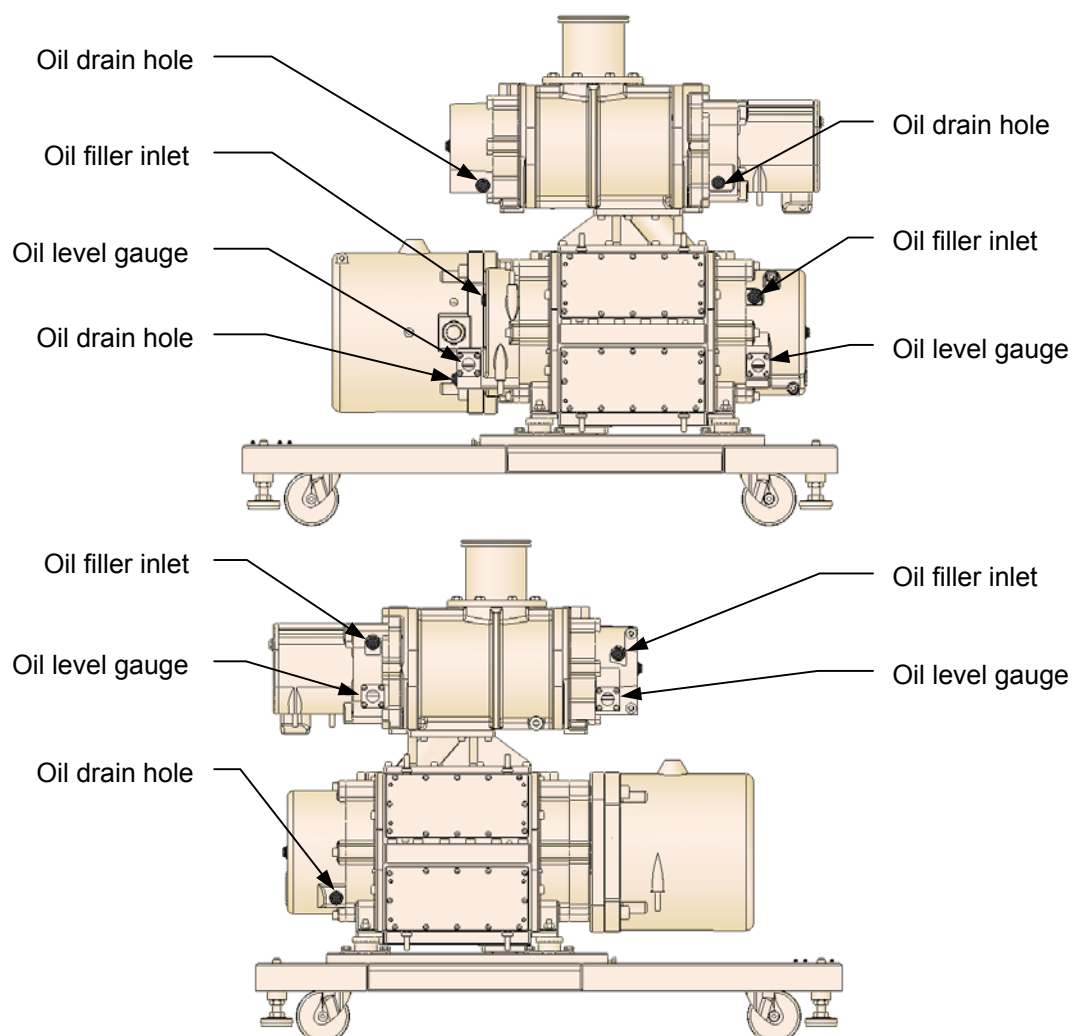

Fig. 8.2 Oil filler port, oil level gauge, and oil drain port positions

- (7) Please check the air leak after supplying lubricant oil.

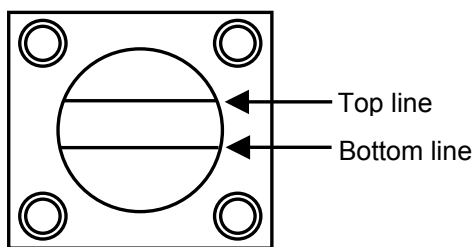

Fig. 8.3 Oil Level Gauge

- ⚠ CAUTION** Be sure to use the lubricant oils listed in specification table 3.1 only.

- ⚠ CAUTION** When the lubrication oil level exceeds the upper limit, the oil may leak to the pump side. Thus, be sure not to exceed the upper limit line when adding the oil. (Except Booster pump gear side.)

- ⚠ CAUTION** When the lubrication oil level is lower than the lower limit line, serious failure may be caused. If you find out the shortage, add the oil immediately.

8.5 Spare (Maintenance) Parts List

Following parts are needed for maintenance in customer's site.

Table. 8.2

1. Standard consumption Part.

Parts' Name	Type	Order No.
Lubricant oil	BARRIERTA J100ES	C-0402-000-0111

2. Recommendable Part for Safe Operation.

Parts' Name	Type	Order No.
O-ring (Viton A)	For NW50 center ring	C-1210-353-0001
	G55(For Exh. check valve)	C-1210-089-0201

3. Recommendable Parts for Quick Maintenance.

Parts' Name	Type	Order No.
Exhaust check valve	32X80L	C-2244-031-0001

4. Recommendable Spare Parts. (Not needed for each pump.)

Parts' Name	Type	Order No.
Water flow sensor	20 L/min	C-5137-008-0001
N2 flow sensor	84.4 Pa m ³ /s	C-5138-062-0111
N2 gas pressure regulator	R31-200-C121	C-2250-101-0001

Following labels are attached to pump covers. When they are hard to read for discoloring or peeling off, please stick them again as directed.

Table. 8.3 Labels

Label Name	Part No.
[DANGER] HAZARDOUS WAIGHT DANGER LABEL	C-7110-316-0001
[WARNING] HAZARDOUS VOLTAGE WARNING LABEL	C-7110-313-0001
[WARNING] HIGH TEMPERATURE WARNING LABEL	C-7110-312-0001
[WARNING] HAZARDOUS MATERIAL WARNING LABEL	C-7110-314-0001
[CAUTION] CHARGE MARK LABEL	C-7110-315-0001

8.6 List of wastes during maintenance

Table 8.4 lists wastes from general user maintenance. Dispose the wastes properly according to your local waste disposal regulations in each area.

Table 8.4 List of wastes during maintenance

Part	Equipped on	Remarks
Lubricant oil	Inside of pump module. See section 8.4.	Refer to Appendix 1, 2 for Material Safety Data Sheet.
Lithium battery	CPU board. (No necessary to replace at usual maintenance.)	Refer to Appendix 3 for Material Safety Data Sheet.
O-ring	Connection of vacuum line	Usual industrial waste.

8.7 Overhaul

Some parts used in this pump are consumables. Overhauls including periodical component replacement and inspections ensure safe and high-performance pump operations.

The overhauls require well-trained personnel who have up-to-date knowledge of the pump structure and are familiar with hazardous chemical gases and safe work procedures. Factories where the overhauls are conducted must be equipped with special tools and facilities as well as exhaust air ducts to protect against toxic gas hazards.

Ebara-designated overhaul factories provide services with well-trained personnel and relevant facilities supported by an established supply system of up-to-date pump information and genuine brand name parts. These advantages offer users superior overhaul services for the pumps in various states.

Ebara recommends the users to send the pumps for the periodical overhaul to the Ebara-designated factories. These factories equip special tools, sufficient evacuation duct

Contact EBARA Sales office or Overhaul service center for detail.

To avoid dangers potentially encountered during pump overhauls, follow instructions below to send your pump to an Ebara-designated factory for overhaul or repair.

- (1) Fill all necessary items in a form shown in Appendix 5 and fax it in advance to Ebara Service Center or one of the agents listed in Section 11 of this manual. Ask Ebara service center for latest form. The original copy must accompany the pump you send. Failure to meet these requirements may restrict Ebara from providing any overhaul services to avoid associated risks.
- (2) When you send back the pump to service center in the United States, contact Ebara Service Center first to obtain a RMA number for identification. Enter this RMA number to an Environmental Health & Safety Clearance Form shown in Appendix 5. Ask Ebara Service Center for latest form. Then, fax it in advance to Ebara Service Center and attach its original copy to the pump you send. Be sure to take these prior actions; otherwise Ebara refuses any overhaul services to avoid associated risks.

9. Disconnection and Transportation

 **WARNING** When the pump has been used for exhausting highly toxic gases such as arsenic and mercury compounds, be sure to contact EBARA Corporation before you return the pump. Refer to Appendix 4 and 5 for the format required when customer returns their pump to Ebara service center for overhaul or rebuild

 **CAUTION** In the interest of safety during the transportation, disassembly and cleaning of the pump, be sure to take note of the gases that have been handled.

Toxic gases may be generated from by-products in the piping or pump in pump disconnection from the tool piping for repair and replacement or flange removal for maintenance. Gain relevant information about the process gases from your tool suppliers, and be sure that the gas concentrations in the work areas are at quarter or under the acceptable values specified using appropriate measurement equipment.

Without assurance of gas safety, instruct the workers to wear proper personnel protective equipment if necessary to protect them from gas hazards. The personnel protective equipment must include at least gloves, safety goggles, and a gas mask.

To disconnect and transport the pump, proceed as follows.

- (1) Stop the pump and replace all gases inside the pump by purging them with N2 gas.
- (2) Turn off the power supply to the pump and unplug the power and signal cables.
- (3) After you have fully closed the N2 regulator, remove the N2 pipe, seal off the N2 purge port with a sealing flange.
- (4) Remove the cooling water pipes.
- (5) Remove the vacuum and exhaust pipes and completely seal off the inlet and exhaust ports of the pump with a blind flange or similar seal. Seal off all process gas discharge points such as the differential port by using a blind flange.
- (6) Attach the LCD controller on the front panel of the control board. Fix it

with the tape.

- (7) Wrap the pump in a vinyl sheet.
- (8) Use the eyebolts provided on the pump for slinging the pump to load and unload. Fasten eyebolts completely and push in until flush with the seating surface. For sling, use a wire with a length so that the slinging angle (that is, the angled subtended by the two wires) is within 60 degrees.

⚠ DANGER Do not enter the zone underneath the suspended pump.

⚠ WARNING For lifting the pump, use only qualified operator personnel. Be sure that the wire rope and crane used for lifting the pump are in proper order and match the weight of the pump. To prevent unequal weight distribution, suspend the pump by ensuring that the slinging angle remains symmetrically centered.

⚠ WARNING In case of sling and transportation, be sure not to remain leaning more than 10 deg against a horizontal for 5 minutes. If not, oil leakage will occur.

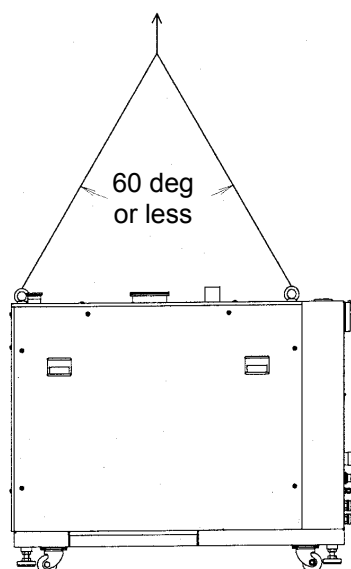

Fig. 9.1 Slinging the Pump

- (9) When options such as an interface box are attached to the pump, be careful to avoid damage due to contact by the wire rope.

- (10) For transportation, secure the pump by lowering the adjustment feet. Place a protective cloth around the pump to avoid shock and position protective members between the outer cover and the wires in order to distribute the load of the fastening wires.

To avoid dangers potentially encountered during pump overhauls, follow instructions shown in Section 8.7, Appendix 4 and 5 to send your pump to an Ebara-designated factory for overhaul or repair.

10. Troubleshooting

10.1 Troubleshooting (1) Basic trouble

 **WARNING** Interrupt Earth Leakage Breaker (ELB) before starting on wiring and maintenance work.
Do not switch on the power supply to the pump until work is completed.

 **WARNING** The pump casing and exhaust piping become extremely hot during operation and for some time after stopping.
Be sure that pump and exhaust piping do not come in contact with humans or inflammable substances.
Do not remove the pump cover during operation.

 **WARNING** Check for gas leaks after installing and maintaining the piping.
Gas leaks will result in the discharge of harmful and dangerous substances and in abnormal reactions due to the ingress of air into the pump. When checking for gas leaks by pressurization, please pressurize by less than 0.05 MPa into the purge port and do check.

Abnormal symptom	Check Item	Corrective Action
Circuit breaker is activated. (Leakage detector is on.)	Incorrect wiring	Check wiring.
	Short circuit	Replace or overhaul pump.
Power LED does not come on.	No power supply to pump.	Check power supply.
	connector is not connected.	Connect power connector.
	CB is not ON.	Place CB to ON.
Nothing appears on LCD	CB is not ON.	Place CB to ON.
	Disconnection of the LCD's connector	Connect LCD's connector
	Instrument failure	Replace instruments.
MP does not start when applying START button.	"Remote" mode has been selected.	Set switch to "Local" mode.
	Start-up conditions are not satisfied. ("Startfail" is displayed.)	Satisfy all start-up conditions.
	Instrument failure	Replace instrument.
MP does not start when entering external "MP start" signal input.	"Local" mode has been selected.	Set switch to "Remote".
	Start-up conditions are not satisfied. ("Startfail" is displayed.)	Satisfy all start-up conditions.
	Instrument failure	Replace instrument.
BP does not start.	BP start signal is not entered in REMOTE mode.	Enter the start signal.
	Instrument failure	Replace instruments.
Abnormal noise Excessive vibration	Adjustment feet are not applied.	Use the adjustment feet.
	Some object is making contact with the outer cover.	Remove the object.
	The fastening screws of the outer cover have worked themselves loose.	Tighten the fastening screws.
	Parts of the pump are damaged.	Replace or overhaul pump.
Vacuum pressure increase.	Accumulation of by-products in pipes.	Clean piping.
	N2 pressure setting is high.	Set pressure for correct value.
	Leak from vacuum piping.	Check piping.
	Accumulation of by-products in pumps.	Replace or overhaul pump.
MEMORY ERROR is displayed on LCD after activating ELB or changing the dip switch setting	None	Need "Countermeasure against electric Noise" to pump.

10.2 Troubleshooting (2) WARNING

 **WARNING** Interrupt Earth Leakage Breaker (ELB) before starting on wiring and maintenance work.
Do not switch on the power supply to the pump until work is completed.

 **WARNING** The pump casing and exhaust piping become extremely hot during operation and for some time after stopping.
Be sure that pump and exhaust piping do not come in contact with humans or inflammable substances.
Do not remove the pump cover during operation.

 **WARNING** Check for gas leaks after installing and maintaining the piping.
Gas leaks will result in the discharge of harmful and dangerous substances and in abnormal reactions due to the ingress of air into the pump. When checking for gas leaks by pressurization, please pressurize by less than 0.05 MPa into the purge port and do check.

Display	Symptom	Check Item	Corrective Action
WARN: WATER FLOW LOW ###	Water flow is reduced.	Coupler is disconnected.	Connect coupler.
		Pressure is not sufficient.	Apply sufficient pressure.
		Root valve is closed.	Open valve.
		Water pipe is clogged.	Clean or replace piping.
		Tube fittings are loosened.	Re-tighten.
		Instrument failure	Replace instrument.
		Outlet & inlet pipes are reverse. (flow value 0 L/min)	Connect pipes correctly.
WARN: PUMP N2 FLOW LOW	Pump N2 flow is reduced.	N2 port is not connected.	Connect N2 pipe fitting.
		Primary pressure is insufficient.	Apply sufficient pressure.
		Regulator setting value LOW.	Increase pressure setting.
		N2 pipe is clogged.	Replace N2 piping.
		Leaks on N2 pipe.	Check the fittings.
		Instrument failure	Replace instrument.
WARN: MP CASING TEMP HIGH	MP Casing temperature rises.	Duct ventilation insufficient	Ventilate sufficiently.
		Pump back pressure rises.	Check exhaust pipe
		Increase of the gas load.	Reduce the inflow gas amount.
		Accumulation of by-product	Replace or overhaul pump.
		Cooling water flow is reduced.	Increase cooling water flow.
WARN: BP MOTOR TEMP HIGH WARN: MP MOTOR TEMP HIGH	Booster Pump (BP) motor coil temp. rises. Main pump (MP) motor coil temp. rises.	Cooling water flow is reduced.	Cool pump thoroughly and reset.
WARN: BP DRIVER TEMP HIGH #####	Booster Pump (BP) driver temp. rises.	Duct ventilation insufficient	Ventilate sufficiently.
		Cooling water flow is reduced.	Increase cooling water flow.
WARN: ## COMM.ERROR	Communication is not established.	Connection error of the instrumented units	Check the connection of the instrumented unit.
		Instrument failure	Replace instrument.
ALARM: PUMP BOX TEMP HIGH	Temp. rises in pump cover.	Duct ventilation not sufficient	Ventilate sufficiently.
		Cooling water flow is reduced.	Increase cooling water flow.
WARN: OIL LEVEL LOW	Oil level is low.	Check oil level. (See Fig.8.1)	Charge lubrication oil.

After you have taken the remedial actions above, reset the pump. If the problem that has caused the WARNING signal still remains, the WARNING display will appear again even after you have reset.

10.3 Troubleshooting (3) ALARM

 **WARNING** Interrupt Earth Leakage Breaker (ELB) before starting on wiring and maintenance work.
Do not switch on the power supply to the pump until work is completed.

 **WARNING** The pump casing and exhaust piping become extremely hot during operation and for some time after stopping.
Be sure that pump and exhaust piping do not come in contact with humans or inflammable substances.
Do not remove the pump cover during operation.

 **WARNING** Check for gas leaks after installing and maintaining the piping.
Gas leaks will result in the discharge of harmful and dangerous substances and in abnormal reactions due to the ingress of air into the pump. When checking for gas leaks by pressurization, please pressurize by less than 0.05 MPa into the purge port and do check.

Display	Symptom	Check Item	Corrective Action
ALARM: WATER FLOW LOW	Water flow is reduced.	Coupler is disconnected.	Connect coupler.
		Pressure is not sufficient.	Apply sufficient pressure.
		Root valve is closed.	Open valve.
		Water pipe is clogged.	Clean or replace piping.
		Tube fittings are loosened.	Re-tighten.
		Instrument failure	Replace instrument.
		Outlet & inlet pipes are reverse. (flow value 0 L/min)	Connect pipes correctly.
ALARM: MP CASING TEMP HIGH	MP Pump casing temp. rises.	Insufficient ventilation	Ventilate sufficiently
		Pump back press. rises.	Check exhaust pipe & silencer.
		Increase of the gas load.	Reduce the inflow gas amount.
		Cooling water flow is reduced.	Cool pump thoroughly and reset.
		Accumulation of by-products	Replace or overhaul pump.
ALARM:BP MOTOR TEMP H.HIGH ALARM:MP MOTOR TEMP H.HIGH	Booster Pump (BP) motor coil temp. rises. Main Pump (MP) motor coil temp. rises.	Cooling water flow is reduced.	Cool pump thoroughly and reset.
		Motor failure	Replace or overhaul pump.
ALARM:BP MOTOR OVERLOAD ALARM:MP MOTOR OVERLOAD	BP motor current rises. (thermal relay trip)	Pump back press. rises.	Check exhaust pipe & silencer.
		Increase of the gas load.	Reduce the inflow gas amount.
	MP motor current rises. (thermal relay trip)	Rotor makes contact. (Accumulation of by-products) (Substance plunge)	Replace or overhaul pump.
		Open phase	Loss of the phase in power source
		Instrument failure	Replace instrument.
ALARM:BP MOTOR STEP OUT	Booster Pump (BP) motor step out	Pump back press. rises.	Check exhaust pipe.
		Increase of the gas load.	Reduce the inflow gas amount.
	Can not restart	Rotor makes contact. (Accumulation of by-products) (Substance plunge)	Replace or overhaul pump.
		Instrument failure	Replace instrument.
ALARM :MP NO CURRENT	MP motor current value is 0.	Instruments are in failure.	Replace instruments.

ALARM: BP DRIVER ###	BP Motor driver protection	Insufficient ventilation	Ventilate sufficiently.
		Pump back press. rises.	Check exhaust pipe.
	Can not restart	Increase of the gas load.	Reduce the inflow gas amount.
		Rotor makes contact. (Accumulation of by-products) (Substance plunge)	Replace or overhaul pump.
		Cooling water flow rate is reduced.	Cool pump thoroughly and reset.
		Motor driver has broken down.	Replace motor driver.
ALARM: PHASE ERROR	Open phase	Instrument failure	Replace instrument.
		Incorrect wiring	Check power supply
ALARM:STARTFAIL ALARM/WARN EXIST	Start fault	Starting during WARNING/ALARM status	Make sure that all starting conditions are met.
		Instrument failure	Replace instrument.

After you have taken the remedial actions above, reset the pump. If the problem that has caused the ALARM signal still remains, the ALARM display will appear again even after you have reset.

During REMOTE operation carry out the above procedures after you have turned off the external start signal.

When the external start signal remains on in the ALTERNATE mode, the pump will start immediately when the RESET signal is applied.

10.4 Troubleshooting (4) Option

⚠ WARNING Interrupt Earth Leakage Breaker (ELB) and lockout before starting on wiring and maintenance work.
Do not switch on the power supply to the pump until work is completed.

⚠ WARNING The pump casing and exhaust piping become extremely hot during operation and for some time after stopping.
Be sure that pump and exhaust piping do not come in contact with humans or inflammable substances.
Do not remove the pump cover during operation.

⚠ WARNING Check for gas leaks after installing and maintaining the piping. Gas leaks will result in the discharge of harmful and dangerous substances and in abnormal reactions due to the ingress of air into the pump. When checking for gas leaks by pressurization, please pressurize by less than 0.05 MPa into the purge port and do check.

Display	Symptom	Check Item	Corrective Action
ALARM: WATER LEAKAGE	Water leakage	Tube fittings are loosened.	Re-tighten.
		Instrument failure	Replace instrument.
ALARM: BACK PRESS.HIGH	Exhaust pressure rises.	Exhaust valve is closed.	Check exhaust pipe.
		Instrument failure	Replace instrument.
WARN: BACK PRESS. ##.#	Exhaust pressure rises.	Exhaust valve is closed.	Check exhaust pipe.
		Instrument failure	Replace instrument.
ALARM: EMERGENCY STOP	Emergency Stop switch	Stop by emergency Stop button.	Check that pump can be operated and turn the button head to release lock.

After you have taken the remedial actions above, reset the pump. If the problem that has caused the ALARM signal still remains, the ALARM display will appear again even after you have reset.

During REMOTE operation carry out the above procedures after you have turned off the external start signal.

When the external start signal remains on in the ALTERNATE mode, the pump will start immediately when the RESET signal is applied.